

E-DWT-10000-AF
Electronic Deadweight Tester
Operation and Maintenance Manual
NSN 6685-01-566-1341



High pressure liquids and gases are potentially hazardous. Energy stored in these liquids and gases can be released unexpectedly and with extreme force. High pressure systems should be assembled and operated only by personnel who have been instructed in proper safety practices.



This instrument is not to be operated in any other manner than that specified by the manufacturer.

© 2008 DH Instruments, a Fluke Company All rights reserved.

Information in this document is subject to change without notice. No part of this document may be reproduced or transmitted in any form or by any means, electronic or mechanical, for any purpose, without the express written permission of **DH Instruments, a Fluke Company** 4765 East Beautiful Lane, Phoenix AZ 85044-5318, USA.

DH Instruments makes sincere efforts to ensure accuracy and quality of its' published materials; however, no warranty, expressed or implied, is provided. **DH Instruments** disclaims any responsibility or liability for any direct or indirect damages resulting from the use of the information in this manual or products described in it. Mention of any product or brand does not constitute an endorsement by **DH Instruments** of that product or brand. This manual was originally composed in English and was subsequently translated into other languages. The fidelity of the translation cannot be guaranteed. In case of conflict between the English version and other language versions, the English version predominates.

Products described in this manual are manufactured under international patents and one or more of the following U.S. patents: 5,142,483; 5,257,640; 5,331,838; 5,445,035. Other U.S. and international patents pending.

AutoRange, AutoZ, **DH Instruments**, **DH**, **DHI**, CalTool, COMPASS, E-DWT, RPM4-E-DWT, QDUT, Q-RPT and SDS are trademarks, registered and otherwise, of **DH Instruments, a Fluke Company**.

Document No. 3338242
DHI Document No. 550166b
080624
Printed in the USA

TABLE OF CONTENTS



TABLE OF CONTENTS	I
TABLES	V
FIGURES.....	VI
ABOUT THIS MANUAL	VII
1. INTRODUCTION	1
1.1 PRODUCT OVERVIEW	1
1.2 SPECIFICATIONS	2
1.2.1 GENERAL SPECIFICATIONS.....	2
1.2.2 BATTERY AND CHARGER PACK	3
1.2.3 PRESSURE MEASUREMENT SPECIFICATIONS	3
1.2.3.1 REFERENCE PRESSURE TRANSDUCERS (RPT)	3
1.2.3.2 ON-BOARD BAROMETER	4
1.3 VIEWS AND SCHEMATICS	4
1.3.1 E-DWT-10000-AF VIEWS.....	4
1.3.1.1 FRONT VIEW.....	4
1.3.1.2 REAR VIEW	5
1.3.2 RPM4-E-DWT REFERENCE PRESSURE MONITOR VIEWS.....	5
1.3.2.1 FRONT PANEL	5
1.3.2.2 REAR PANEL.....	6
1.3.3 BATTERY/CHARGER PACK VIEWS	6
1.3.4 E-DWT-10000-AF DIMENSIONS.....	7
1.3.5 E-DWT-10000-AF HYDRAULIC SCHEMATIC.....	7
2. INSTALLATION	9
2.1 UNPACKING AND INSPECTION	9
2.1.1 REMOVING FROM PACKAGING	9
2.1.2 INSPECTING CONTENTS.....	9
2.2 SITE REQUIREMENTS.....	10
2.3 SETUP	10
2.3.1 PREPARING FOR OPERATION.....	10
2.3.2 SETTING UP AUTOTEST FILES	10
2.4 OPERATIONAL CHECK.....	11
2.4.1 RPM4-E-DWT PRESSURE MEASUREMENT	11
2.4.2 E-DWT PRESSURE GENERATION AND CONTROL	11
2.5 SHORT TERM STORAGE	12
2.6 LONG TERM STORAGE, PREPARATION FOR SHIPPING.....	13
3. OPERATION.....	15
3.1 GENERAL OPERATING PRINCIPLES	15
3.1.1 MULTIPLE RANGES (HI AND LO Q-RPT, AUTORANGE).....	15
3.1.2 PRESSURE READY/NOT READY.....	16
3.1.3 AUTOMATED TEST AND CALIBRATION SEQUENCES	16
3.1.4 TYPICAL OPERATING SEQUENCE TO RUN A TEST.....	16
3.2 TEST PORT CONNECTION	17
3.2.1 RPM4-E-DWT ATM PORTS	18
3.3 BATTERY/CHARGER PACK	18
3.4 SELECTING THE HI OR LO Q-RPT.....	19
3.5 PRESSURE GENERATION AND ADJUSTMENT.....	22

3.5.1	FILLING AND PRIMING, RESERVOIR PUMP.....	22
3.5.2	PRESSURE GENERATION AND ROUGH ADJUSTMENT, VARIABLE VOLUME.....	23
3.5.3	PRESSURE FINE ADJUSTMENT, FINE ADJUST VALVE.....	24
3.6	RPM4-E-DWT USER INTERFACE.....	24
3.6.1	MAIN RUN SCREEN.....	24
3.6.2	FUNCTION / DATA KEYPAD LAYOUT AND PROTOCOL.....	26
3.6.3	OPTIONAL REMOTE [ENT] (ENTER) FOOTSWITCH.....	26
3.6.4	SOUNDS.....	27
3.7	RPM4-E-DWT DIRECT FUNCTION KEYS.....	27
3.7.1	SUMMARY.....	27
3.7.2	[RANGE].....	28
3.7.3	[UNIT].....	29
3.7.4	[MODE].....	30
3.7.5	[AUTORANGE].....	30
3.7.6	[LEAK CK].....	32
3.7.7	[DISPLAY].....	33
3.7.7.1	AVG (AVERAGE).....	34
3.7.7.2	RATE.....	35
3.7.7.3	DEV (DEVIATION).....	36
3.7.7.4	RPT.....	37
3.7.7.5	HI/LO.....	38
3.7.7.6	FREEZE.....	38
3.7.7.7	CLEAN.....	39
3.7.8	[HEAD].....	39
3.7.9	[SDS].....	41
3.7.10	[AUTOZ].....	41
3.7.11	[ENT] (RUN AUTOTEST).....	42
3.7.11.1	AUTOTEST INITIALIZATION.....	43
3.7.11.2	TEST EXECUTION.....	44
3.8	[SETUP].....	46
3.8.1	<1RANGE>.....	46
3.8.1.1	SAVING AN AUTORANGE RANGE.....	46
3.8.1.2	DELETING AUTORANGE RANGES.....	47
3.8.2	<2RES> (RESOLUTION).....	47
3.8.3	<3STAB> (STABILITY).....	48
3.8.4	<4UL> (UPPER LIMIT).....	49
3.8.4.1	OVER PRESSURE FUNCTION.....	49
3.8.5	<5ATEST>.....	50
3.8.5.1	DATA.....	50
3.8.5.2	FILE.....	51
3.9	[SPECIAL].....	53
3.9.1	<1AUTOZ>.....	54
3.9.2	<2REMOTE>.....	55
3.9.2.1	<1COM1, 2COM2>.....	56
3.9.2.2	<3IEEE-488>.....	56
3.9.2.3	<4FORMAT>.....	56
3.9.2.4	<5RS232 SELF-TEST>.....	56
3.9.3	<3HEAD>.....	57
3.9.4	<4SDS>.....	57
3.9.5	<5PREFS>.....	57
3.9.5.1	<1SCRSVR>.....	58
3.9.5.2	<2SOUND>.....	58
3.9.5.3	<3TIME>.....	59
3.9.5.4	<4ID>.....	59
3.9.5.5	<5LEVEL> (SECURITY).....	60
3.9.6	<6PUNIT>.....	62
3.9.7	<7INTERN>.....	63
3.9.7.1	<1BARO>.....	64
3.9.7.2	<2READRT>.....	64
3.9.7.3	<3RPT2X>.....	65
3.9.7.4	<4LO VNT>.....	65
3.9.7.5	<5LOG>.....	65
3.9.8	<8CAL>.....	66
3.9.9	<9RESET>.....	66
3.9.9.1	<1SETS>.....	66
3.9.9.2	<2 UNITS>.....	67
3.9.9.3	<3ATEST>.....	67
3.9.9.4	<4 CAL>.....	67
3.9.9.5	<5 ALL>.....	68

4.	REMOTE OPERATION	69
4.1	OVERVIEW	69
4.2	INTERFACING.....	69
4.2.1	RS232 INTERFACE.....	69
4.2.1.1	COM1.....	69
4.2.1.2	COM2.....	70
4.3	PROGRAMMING FORMATS.....	70
4.3.1	PROGRAM MESSAGE FORMAT	70
4.3.2	ERROR QUEUE.....	71
4.3.2.1	USING QUERY TYPE COMMANDS.....	71
4.4	COMMANDS.....	72
4.4.1	PROGRAMMING MESSAGES.....	72
4.4.2	ERROR MESSAGESS.....	73
4.4.3	PROGRAM MESSAGE DESCRIPTION OVERVIEW.....	74
4.4.4	PROGRAM MESSAGE DESCRIPTIONS.....	75
5.	MAINTENANCE, ADJUSTMENTS AND CALIBRATION	93
5.1	OVERVIEW	93
5.2	RPM4-E-DWT MAINTENANCE	93
5.2.1	AUTOZERO OF Q-RPTS.....	93
5.2.2	ADJUSTMENT OF THE ON-BOARD BAROMETER.....	94
5.3	RPM4-E-DWT Q-RPT CALIBRATION.....	94
5.3.1	PRINCIPLE	94
5.3.1.1	PA AND PM COEFFICIENTS	95
5.3.2	EQUIPMENT REQUIRED	95
5.3.3	SET-UP AND PREPARATION	96
5.3.4	RECOMMENDED CALIBRATION POINT SEQUENCE	96
5.3.5	RPT CALIBRATION USING CALTOOL FOR Q-RPTS SOFTWARE	97
5.3.6	EDITING AND VIEWING Q-RPT CALIBRATION INFORMATION	97
5.3.7	Q-RPT ADJUSTMENT WITHOUT CALTOOL FOR Q-RPTS SOFTWARE.....	98
5.4	E-DWT MAINTENANCE	99
5.4.1	E-DWT OVERHAUL.....	99
5.5	E-DWT REPAIR	100
5.5.1	REMOVING RPM4-E-DWT FROM THE E-DWT	100
5.5.2	OPENING AND CLOSING THE RPM4-E-DWT ENCLOSURE.....	101
5.5.3	RELOADING EMBEDDED SOFTWARE INTO RPM4-E-DWT FLASH MEMORY	101
5.5.4	REPLACING THE E-DWT HIGH PRESSURE RUPTURE DISK	102
5.5.5	RPM4-E-DWT SUBASSEMBLY DESCRIPTION AND LOCATION	104
5.5.5.1	MICRO BOARD.....	105
5.5.5.2	DRIVER BOARD	105
5.5.5.3	ON-BOARD BAROMETER	105
5.5.5.4	Q-RPT MODULE	105
5.5.5.5	DISPLAY	106
5.5.5.6	COOLING FAN.....	106
5.5.6	HYDRAULIC SCHEMATIC OF Q-RPT MODULE	106
5.6	ILLUSTRATED PARTS BREAKDOWN	106
5.6.1	E-DWT-10000-AF ILLUSTRATED PARTS BREAKDOWN	106
5.6.2	E-DWT-10000-AF DETAILED HYDRAULIC SCHEMATIC	109
5.6.3	RPM4-E-DWT A70M/A7M-AF ILLUSTRATED PARTS BREAKDOWN.....	111
6.	TROUBLESHOOTING	115
7.	APPENDIX	119
7.1	UNIT CONVERSION.....	119
7.1.1	PRESSURE.....	119
8.	WARRANTY	121
8.1	OVERVIEW	121
9.	GLOSSARY	123

NOTES



TABLES

Table 1. E-DWT-10000-AF packing list	9
Table 2. Settings and what they are specific to (range, measurement mode, Q-RPT, system).....	16
Table 3. Summary of RPM4-E-DWT function key operation	27
Table 4. Settings made by AutoRange	31
Table 5. Security levels	61
Table 6. UNIT function - available units of measure.....	63
Table 7. READRT – display update rates	64
Table 8. Reset – Sets.....	67
Table 9. Reset – Cal	68
Table 10. Reset – All.....	68
Table 11. COM1 pin designations and connections	69
Table 12. COM2 DB-9F pin designations	70
Table 13. Program message list	72
Table 14. Error #s and descriptions	73
Table 15. Calibration point sequence for A7M and A70M Q-RPTs	97
Table 16. E-DWT exterior illustrated parts breakdown (see Figure 16)	107
Table 17. E-DWT internal illustrated parts breakdown (see Figure 17).....	108
Table 18. E-DWT-10000-AF, detailed hydraulic schematic illustrated parts breakdown (see Figure 18)	109
Table 19. RPM4-E-DWT rear panel, external view illustrated parts breakdown (see Figure 19)	111
Table 20. RPM4-E-DWT Q-RPT assembly, internal view illustrated parts breakdown (see Figure 20)	112
Table 21. RPM4-E-DWT overall, interior view illustrated parts breakdown (see Figure 21)	113
Table 22. RPM4-E-DWT display assembly, interior view illustrated parts breakdown (see Figure 22)	114
Table 23. Troubleshooting guide	115
Table 24. Pressure unit of measure conversion coefficients	119
Table 25. DHI Authorized Service Providers	121

FIGURES

Figure 1. E-DWT-10000-AF front view..... 4

Figure 2. E-DWT-10000-AF rear view 5

Figure 3. RPM4-E-DWT reference pressure monitor front panel 5

Figure 4. RPM4-E-DWT reference pressure monitor rear panel 6

Figure 5. Battery/charger pack front and rear E-DWT-10000-AF dimensions..... 6

Figure 6. E-DWT-10000-AF dimensions..... 7

Figure 7. E-DWT-10000-AF hydraulic schematic 7

Figure 8. Battery pack/charger..... 19

Figure 9. E-DWT-10000-AF front view..... 21

Figure 10. E-DWT-10000-AF hydraulic schematic 21

Figure 11. MAIN RUN screen display fields..... 25

Figure 12. Keypad layout 26

Figure 13. RPM4-E-DWT removal from E-DWT 101

Figure 14. RPM4-E-DWT internal view 104

Figure 15. Hydraulic schematic RPM4-E-DWT Q-RPT Module 106

Figure 16. E-DWT exterior view 107

Figure 17. E-DWT internal view 108

Figure 18. E-DWT detailed hydraulic schematic..... 110

Figure 19. RPM4-E-DWT rear panel, external view illustrated parts breakdown 111

Figure 20. RPM4-E-DWT Q-RPT assembly, internal view illustrated parts breakdown 112

Figure 21. RPM4-E-DWT overall, interior view illustrated parts breakdown..... 113

Figure 22. RPM4-E-DWT display assembly, interior view illustrated parts breakdown..... 114

ABOUT THIS MANUAL



This manual is intended to provide the user with the basic information necessary to operate an E-DWT-10000-AF electronic deadweight tester (Portable Hydraulic Gauge Calibrator). It also includes a great deal of additional information provided to allow you to optimize the use of the instrument and take full advantage of its many features and functions.

Before using the manual, take a moment to familiarize yourself with the Table of Contents structure: Sections 1.1, 2 and 3. Section 4 is for remote communication with the RPM4-E-DWT from an external computer. Section 5 provides maintenance and calibration information. Section 6 is a quick troubleshooting guide. Use it to troubleshoot unexpected E-DWT behavior based on the symptom of that behavior.



For those of you who “don’t read manuals”, go directly to Section 2.3 to set up your E-DWT and then go to Section 3.1.4 for a typical test procedure. This will get you up and running quickly with a minimal risk of causing damage to yourself or your new instrument. THEN... when you have questions or start to wonder about all the great features you might be missing, get into the manual!

Manual Conventions



(CAUTION) is used in throughout the manual to identify user warnings and cautions.



(NOTE) is used throughout the manual to identify operating and applications advice and additional explanations.

[] indicates direct function keys (e.g., **[RANGE]**).
< > indicates RPM4-E-DWT screen displays (e.g., **<1yes>**).

NOTES



1. INTRODUCTION

1.1 PRODUCT OVERVIEW

E-DWT-10000-AF is an electronic deadweight tester designed to replace mechanical piston-cylinder based deadweight testers with a lighter weight, easier to use alternative. The E-DWT is designed to be used in the lab or instrument shop or to be taken into the field for performing in-situ calibrations and tests. This high performance hydraulic pressure calibration system combines an electronic reference pressure monitor and manually operated pressure generation and control hardware in a single, compact and rugged package. E-DWT offers the ease of use and precision of continuous, real time electronic pressure measurement with the simple and direct pressure control of high quality manual pressure hardware.

The electronic reference pressure monitor is a special version of DHI's RPM4, designated RPM4-E-DWT A70M/A7M-AF. RPM4-E-DWT A70M/A7M-AF covers the range from 0 to 10 000 psi gauge pressure using two high precision quartz reference pressure transducers (Q-RPTs) and an on-board barometer to measure pressure.

RPM4-E-DWT A70M/A7M-AF is controlled locally by the operator using its front panel display, keypad and foot pedal or remotely by a computer using ASCII character command strings over its RS-232 interface.

RPM4-E-DWT A70M/A7M-AF uses an AutoRange feature to automatically select the most appropriate Q-RPT and to optimize the E-DWT setup to cover the desired range of operation. A half-turn valve isolates and protects the Lo Q-RPT from high pressure when the Hi Q-RPT is in use. Visual and audible indicators assist the operator in setting the shut off valve correctly.

The E-DWT includes the hardware necessary to fill the system under test with oil and generate and precisely adjust pressure across the E-DWT's 10 000 psi (70 MPa) range.

The E-DWT-10000-AF system is delivered in a rugged, molded plastic transport case and includes two battery/charger packs.

1.2 SPECIFICATIONS

1.2.1 GENERAL SPECIFICATIONS

Power requirements:
To RPM4-E-DWT: 12 VDC, 1.2 A
To 12 VDC AC to DC power supply : 100 to 240VAC, 50-60 Hz

Temperature
Operating: 18 to 28 °C
Storage: - 20 to 70 °C

Weight
E-DWT-10000-AF unit: 14 kg (30 lb) approx.
E-DWT system w/ accessories in case: 27.3 kg (60 lb) approx.

Dimensions
E-DWT-10000-AF footprint: 41.4 cm W x 37.1 cm D (16.3 in. x 14.6 in.)
E-DWT-10000-AF height: 26.9 cm (10.6 in.), 33.6 cm (13.2 in.) to max variable volume handle stroke
System transport case: 39.4 cm H x 79.5 cm W x 51.8 cm D (15.5 in. x 31.3 in. x 20.4 in.)

Pressure range: 0 to 10 000 psi (70 MPa) gauge pressure

Operating medium: Oil (di-ethyl-hexyl sebacate)

Reservoir capacity: 300 cc (18 in.³)

Variable volume displacement: 3 cc (0.18 in.³)

Priming pump displacement: 3.7 cc (0.23 in.³)

TEST pressure connection: DH500 female, adaptors to 1/4 in. and 1/8 in. NPT female included.

 *DH500 is a gland and collar type fitting for 6mm (1/4 in.) coned and left hand threaded tubes equivalent to AE F250C, HIP HF4, etc.*

Pressure Limits: Maximum Working Pressure: 10 000 psi (70 MPa)
Maximum Pressure Without Damage: 12 000 psi (83 MPa)
Internal rupture disk burst pressure: 11500 psi (79 MPa)

When Lo Q-RPT is connected to TEST pressure:

Maximum Working Pressure: 1 000 psi (7 MPa)
Maximum Pressure Without Damage: 2200 psi (15.2 MPa)
Pressure relief valve setting: 1 500 psi (10.3 MPa)

Maximum priming pump pressure: 100 psi (700 kPa)

Communication ports: RS232 (COM1, COM2)

1.2.2 BATTERY AND CHARGER PACK

Power Requirements	100 to 240 VAC, 50/60 Hz, 15 W max consumption
Operating Temperature Range	0 to 50 °C
Storage Temperature Range	- 20 to 70 °C
Weight	2 kg (4.4 lb)
Dimensions	8 cm H x 22.5 cm W x 20 cm D (3.1 in. x 8.9 in. x 7.9 in.)
Battery Type	Nickel metal-hydride
Battery Voltage	12 VDC
Battery Capacity	Typical: 9000 mAh Min: 8200 mAh
Charge Time	Full charge from empty, 14 to 16 hours approx.
Approx. Run Time, Full Charge	8 to 12 hours

1.2.3 PRESSURE MEASUREMENT SPECIFICATIONS

1.2.3.1 REFERENCE PRESSURE TRANSDUCERS (RPT)

E-DWT-10000-AF is configured with two quartz reference pressure transducer (Q-RPT) modules to measure pressure.

The Q-RPTs are intrinsically absolute, operating against a sealed vacuum reference. Gauge pressure is defined by offsetting atmospheric pressure and applying dynamic compensation for atmospheric changes using the on-board barometer (see Section 3.9.1).

Warm Up Time	15 minute temperature stabilization recommended from cold power up.	
Compensated Temperature Range	5 to 35 °C	
Operating Temperature Range	18 to 28 °C	
	A7M Q-RPT	A70M Q-RPT
Maximum Range	1 000 psi (7 MPa)	10 000 psi (70 MPa)
Resolution	0.01 % of active range default. User adjustable to 1 ppm of Q-RPT maximum or 10 ppm of active AutoRange, whichever is larger.	
Precision¹	± 0.015 % of reading, or 0.045 psi, whichever is larger	± 0.015% of reading, or 0.45 psi, whichever is larger
Temperature effect²	± 0.0006% of span per °C deviation from calibration temperature (23°C)	
Predicted Stability³	± 0.01% of reading or 0.02 psi, whichever is greater	± 0.01% of reading or 0.1 psi, whichever is greater
Measurement Uncertainty⁴	± 0.1% of reading, or 0.1 psi, whichever is greater	± 0.1% of reading, or 1.0 psi, whichever is greater

1. Combined linearity, hysteresis, and repeatability.
2. Maximum influence of ambient temperature on indicated pressure from 0 to 50°C
3. Predicted Q-RPT measurement stability limit (k=2) over two years assuming regular use of AutoZero function and short term stability between rezeroing. As stability can only be predicted and varies from Q-RPT to Q-RPT, stability for a specific Q-RPT should be established from experience.

4. Maximum deviation of the Q-RPT indication from the true value of applied pressure including precision, predicted two year stability with rezeroing, temperature effect from 18 to 28 °C and calibration uncertainty (assumes calibration reference uncertainty of ±0.02% of reading, k=2), combined and expanded (k=2) following the ISO "Guide to the Expression of Uncertainty in Measurement."

1.2.3.2 ON-BOARD BAROMETER

The measurement uncertainty of the on-board barometer is not significant to E-DWT measurement uncertainty. It is used only to measure small, short term changes in atmospheric pressure to provide dynamic compensation of the Q-RPT's atmospheric pressure offset in gauge pressure measurement mode (see Section 3.9.1)

Sensor Technology: Micro-machined silicon
 Warm Up Time: None required
 Resolution: 0.1 Pa (0.000015 psi)

1.3 VIEWS AND SCHEMATICS

1.3.1 E-DWT-10000-AF VIEWS

1.3.1.1 FRONT VIEW

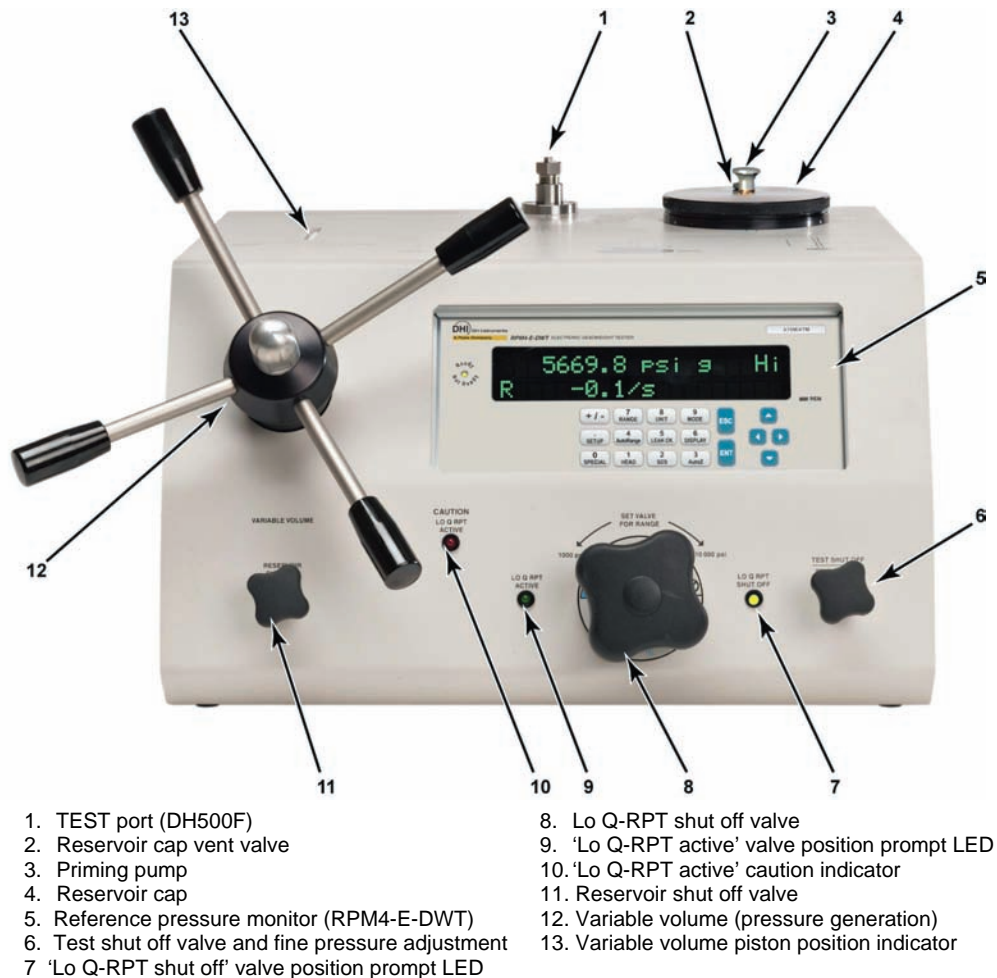

Figure 1. E-DWT-10000-AF front view

1.3.1.2 REAR VIEW

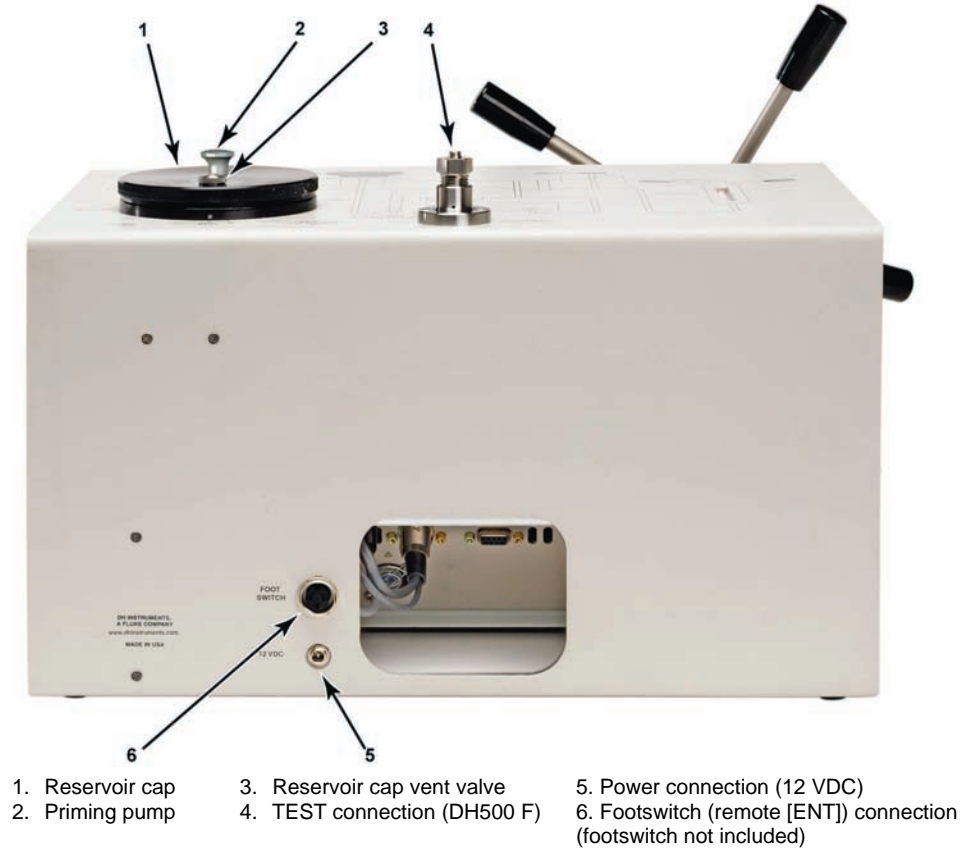

Figure 2. E-DWT-10000-AF rear view

1.3.2 RPM4-E-DWT REFERENCE PRESSURE MONITOR VIEWS

1.3.2.1 FRONT PANEL

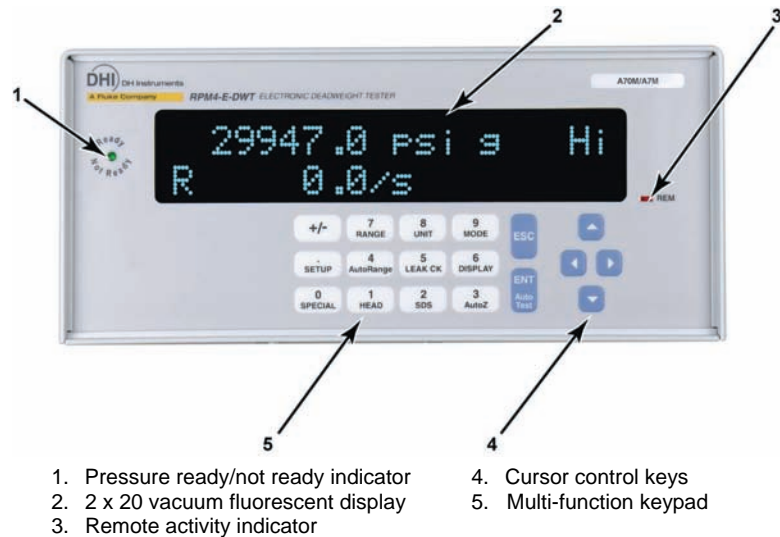
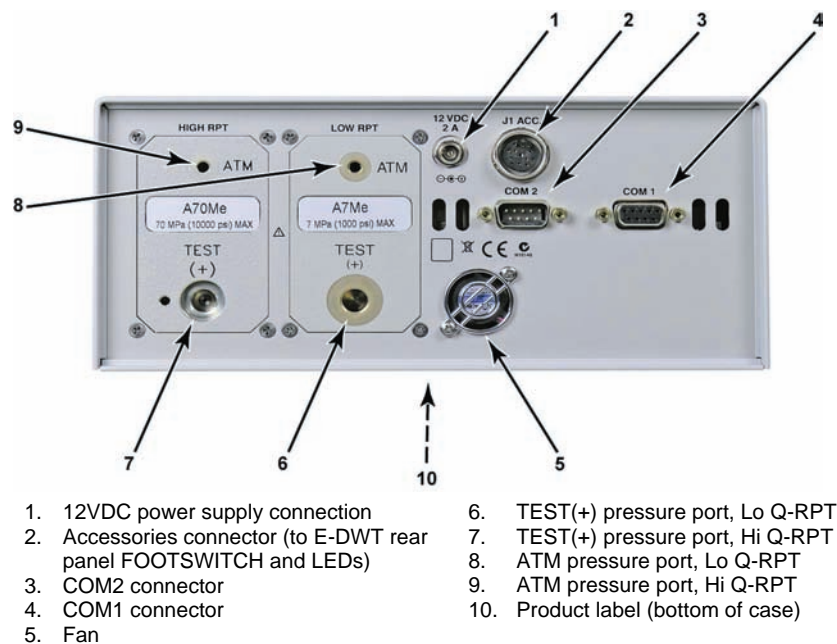

Figure 3. RPM4-E-DWT reference pressure monitor front panel

1.3.2.2 REAR PANEL



- | | |
|--|------------------------------------|
| 1. 12VDC power supply connection | 6. TEST(+) pressure port, Lo Q-RPT |
| 2. Accessories connector (to E-DWT rear panel FOOTSWITCH and LEDs) | 7. TEST(+) pressure port, Hi Q-RPT |
| 3. COM2 connector | 8. ATM pressure port, Lo Q-RPT |
| 4. COM1 connector | 9. ATM pressure port, Hi Q-RPT |
| 5. Fan | 10. Product label (bottom of case) |

Figure 4. RPM4-E-DWT reference pressure monitor rear panel

1.3.3 BATTERY/CHARGER PACK VIEWS

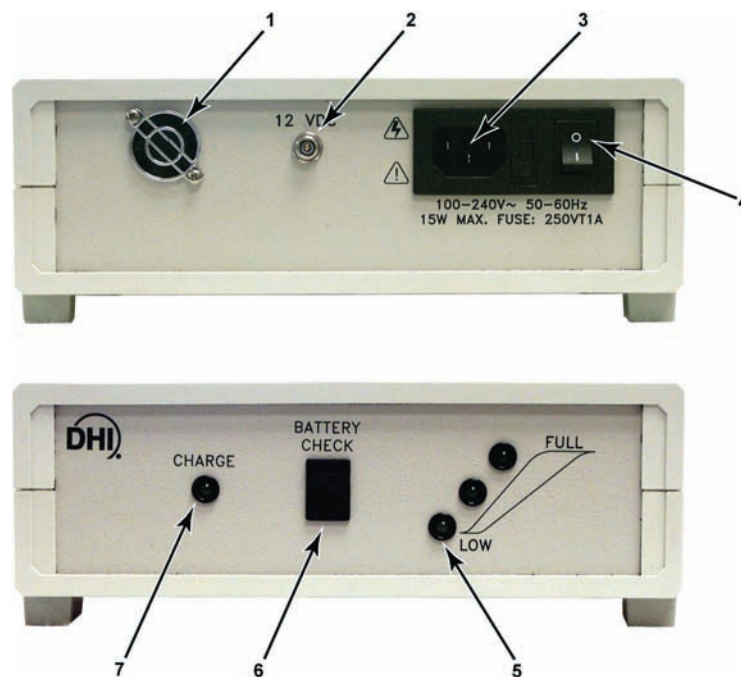

- | | |
|--|--|
| 1. Cooling fan | 5. Charge level indicator |
| 2. 12VDC output connector (to E-DWT) | 6. Charge level check switch |
| 3. IEC power connection | 7. Battery charging indicator (green – charging; green flashing – fully charged) |
| 4. ON/OFF switch (ON – battery connected to charger; OFF - battery connected to 12 VDC output/E-DWT) | |

Figure 5. Battery/charger pack front and rear E-DWT-1000-AF dimensions

1.3.4 E-DWT-10000-AF DIMENSIONS

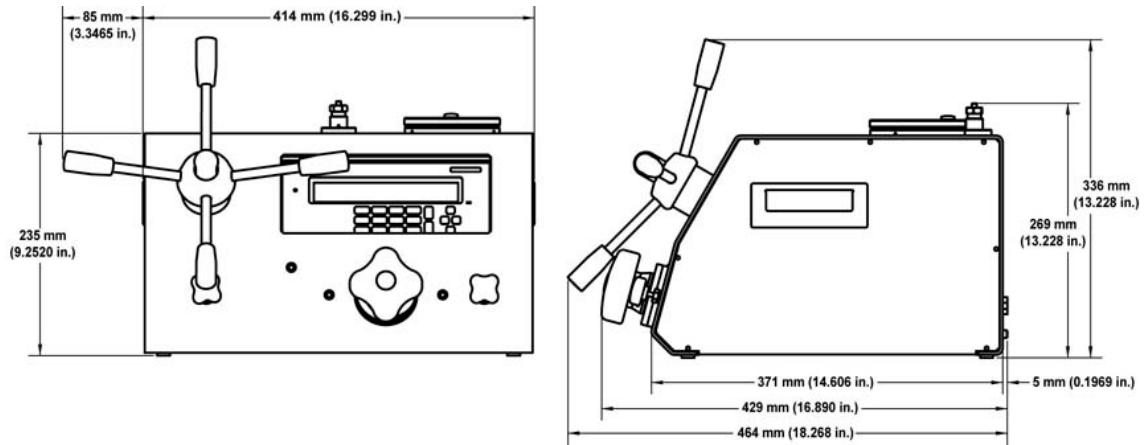
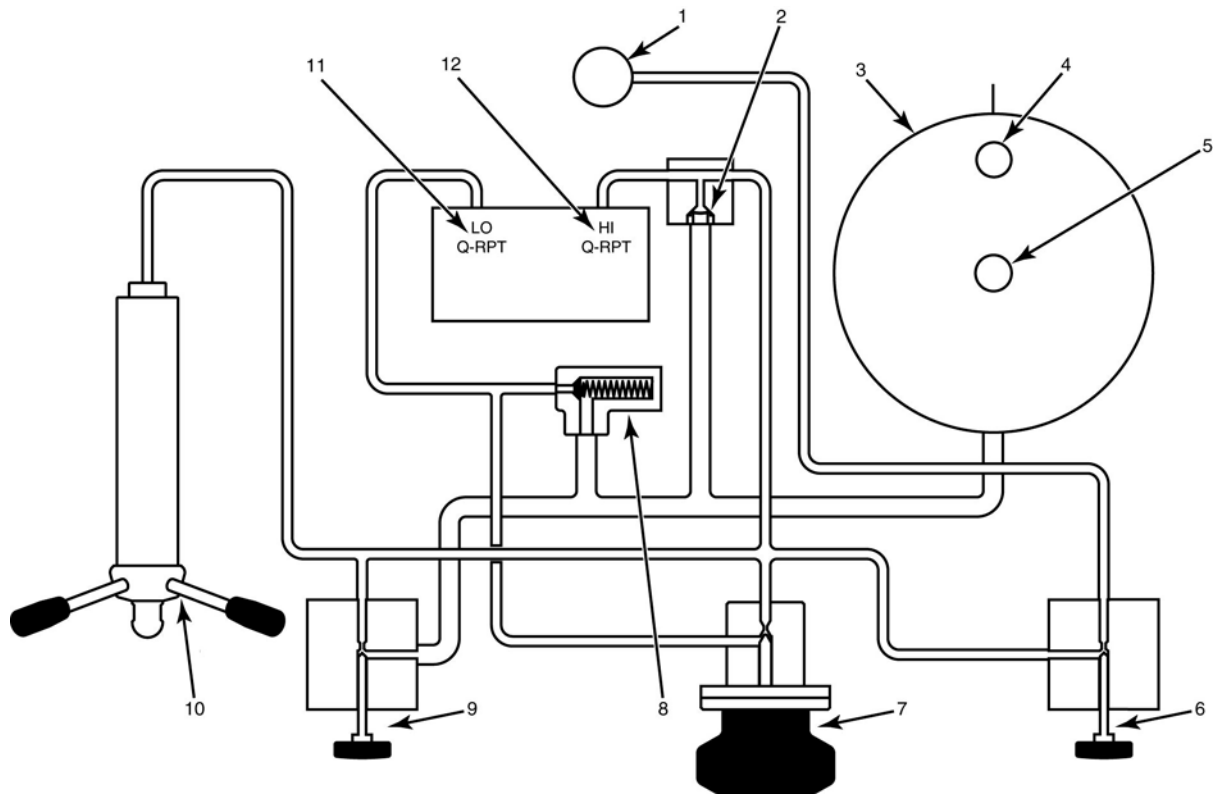

Figure 6. E-DWT-10000-AF dimensions

1.3.5 E-DWT-10000-AF HYDRAULIC SCHEMATIC



- | | |
|--|--|
| 1. TEST port | 8. Lo Q-RPT pressure relief valve |
| 2. System pressure rupture disc | 9. Reservoir shut off valve |
| 3. Reservoir | 10. Variable volume |
| 4. Reservoir vent valve | 11. Lo Q-RPT (ref pressure transducer) |
| 5. Priming pump | 12. Hi Q-RPT (ref pressure transducer) |
| 6. Test shut off and fine adjustment valve | |
| 7. Lo Q-RPT shut off valve | |

Figure 7. E-DWT-10000-AF hydraulic schematic

NOTES

2. INSTALLATION

2.1 UNPACKING AND INSPECTION

2.1.1 REMOVING FROM PACKAGING

E-DWT-10000-AF complete with accessories is delivered in a reusable, molded plastic shipping container with polyurethane inserts to hold it in place.

Remove the E-DWT-10000-AF and its accessories from the shipping container and remove each element from its protective plastic bag.



Retain the shipping container for repacking the E-DWT to take it into the field or to ship it for recalibration or repair.

2.1.2 INSPECTING CONTENTS

Check that all items are present and have no visible damage. If damage is noted, report it to your Receiving Department for appropriate action.

A new E-DWT-10000-AF includes all items listed in Table 1.

Table 1. E-DWT-10000-AF packing list

DESCRIPTION		PART NO.
E-DWT-10000-AF electronic deadweight tester		3322392
ACCESSORIES:		3338865
1 ea.	Transport case (with inserts) (used for original shipment)	3329777
2 ea.	Battery/charger pack	3338787
1 ea.	Battery/charger pack to E-DWT power cable	3335937
2 ea.	Power cord (7.5 ft)	3133781
1 ea.	12 VDC power supply pack	3335610
4 ea.	Handle, variable volume	3329907
1 ea.	DH500 M x 1/4 in. NPT F adaptor	3335561
1 ea.	DH500 M x 1/8 in. NPT F adaptor	3142684
1 ea.	E-DWT-10000-AF Documentation Disk including: <ul style="list-style-type: none"> E-DWT-10000-AF Operation and Maintenance Manual, p/n 550166 	3338256
1 ea.	Calibration Report	3152121
1 ea.	Test Report (included only if the E-DWT-10000-AF is delivered under AFMETCAL contract FY2333-07-M-0025)	3338793
1 ea.	General Accessories Disk	3139043

2.2 SITE REQUIREMENTS

Install E-DWT-10000-AF on a flat, stable surface at a convenient height. If using the battery/charger pack, consider its placement.

When used with its battery/charger pack, E-DWT-10000-AF requires no external support facilities. If not using the battery, an electrical power source of 100 to 240VAC, 50-60 Hz is required.

2.3 SETUP

2.3.1 PREPARING FOR OPERATION

To prepare E-DWT-10000-AF for check out and operation:

- ❶ Remove the protective plastic sheet from the front panel display.
- ❷ Familiarize yourself briefly with the E-DWT front and rear panels and controls (see Section 1.3.1).
- ❸ Connect the 12 VDC power supply pack to a source of 100 to 240V, 50-60 Hz AC power and to the 12 VDC connection on the rear of the E-DWT; or, use the battery/charger pack and cable if battery has been charged (see Section 3.3).

Connecting power causes the RPM4-E-DWT to power up.

- ❹ Observe the front panel display as the RPM4-E-DWT initializes, error checks and goes to the MAIN RUN screen (see Section 3.6.1). If the RPM4-E-DWT fails to reach the main run screen, service is required. Record the sequence of operations and displays observed and contact a **DHI** Authorized Service Provider (see Section 1, Table 25).

Check that one of the two green Valve Status LEDs on the front of the E-DWT is lit (the red LED should NOT be ON). If neither of the green LEDs lights, check that the 12 pin circular connector on the rear panel of the RPM4-E-DWT itself is properly connected to the J1 ACC. connector.

- ❺ Install the four variable volume handles into the variable volume hub on the front of the E-DWT.
- ❻ Leave the stainless steel plug in the top surface TEST port. Check that the gland holding the plug is tight.
- ❼ Check/Set Security Level

RPM4-E-DWT has a security system based on user levels. By default, the security system is set to “low”, which includes access restriction to internal calibration coefficients, and there is no password required to change the security level. See Section 3.9.5.5 for information on the security level system. As part of the RPM4-E-DWT startup, determine the security level that is appropriate for the RPM4-E-DWT and set a password if desired.

 *RPM4-E-DWT is delivered with the security level set to “low” to avoid inadvertent altering of critical internal settings but with access to changing security levels unrestricted. It is recommended that the low security level be maintained at all times and password protection be implemented if control over setting of security levels is desired.*

2.3.2 SETTING UP AUTOTEST FILES

E-DWT’s RPM4-E-DWT supports automated test/calibration sequences. AutoTest sequence parameters for testing specific DUTs can be stored in File AutoTest files and recalled to run a test. Consider setting up File AutoTest files for frequently tested DUTs as part of the E-DWT set up process (see Section 3.1.3).

2.4 OPERATIONAL CHECK

2.4.1 RPM4-E-DWT PRESSURE MEASUREMENT

See Figure 1 and Figure 7 for an E-DWT view and schematic when following this procedure.

- ❶ Check that one of the two green Valve Status LEDs on the front panel of the E-DWT is lit (the red LED should NOT be ON). If neither of the green LEDs on the E-DWT front panel lights, check that the 12 pin circular connector at the rear of the RPM4-E-DWT itself is properly connected to the J1 ACC. connector.
- ❷ Let the RPM4-E-DWT warm up with power ON for approximately 15 minutes.
- ❸ Open the reservoir vent valve by turning it CCW.
- ❹ Open the reservoir shut off valve by turning it CCW.
- ❺ Put the Lo Q-RPT shut off valve into the Lo Q-RPT Active position (turn fully CCW) . This opens the Lo and Hi Q-RPTs to the E-DWT TEST port.
- ❻ Use [RANGE] (see Section 3.7.2) to select the Lo Q-RPT. If desired, change the pressure unit of measure using [UNIT] (see Section 3.7.3).
- ❼ The value indicated should be near zero. Press [AutoZ]. This runs AutoZ to zero the Q-RPT reading (see Section 3.7.10). Upon return to the main run screen, observe that the indication of measured pressure has zeroed. If the display fails to zero properly, the E-DWT may need repair.
- ❽ Use [RANGE] to select the Hi Q-RPT (see Section 3.7.2) and repeat the zeroing process. If the display fails to zero properly, the E-DWT may need repair.



It is normal for RPM4-E-DWT to indicate a value other than zero when vented when gauge mode is first entered or ranges are changed, especially if AutoZ is OFF, RPM4-E-DWT has been OFF for some time or its location has changed.

2.4.2 E-DWT PRESSURE GENERATION AND CONTROL

Perform RPM4-E-DWT pressure measurement operational check (see Section 2.4.1) before the pressure generation and control check.

Refer to Figure 9 and Figure 10 when following this procedure.

- ❶ Check that there is calibration fluid (di-ethyl hexyl sebacate) in the E-DWT reservoir (the E-DWT is supplied with the reservoir full).
- ❷ Open the reservoir vent valve by rotating it CCW.
- ❸ Open the reservoir shut off valve.
- ❹ Set the variable volume to start position. Rotate variable volume handles CCW until red of variable volume piston position indicator on top of E-DWT is fully retracted.
- ❺ Put the Lo Q-RPT shut off valve into the Lo Q-RPT Active position (rotate valve fully CCW). This opens the Lo and Hi Q-RPTs to the E-DWT pressure generation and control system.

Use [RANGE] (see Section 3.7.2) to select the Lo Q-RPT. If desired, change the pressure unit of measure using [UNIT] (see Section 3.7.3).



With the Lo Q-RPT connected, never exceed pressure of 1000 psi (7 MPa) or the Lo Q-RPT could be permanently damaged. If the red CAUTION indicator flashes and/or an audible alarm sounds, immediately reduce pressure to avoid damaging an E-DWT Q-RPT.

- ⑥ Check that the stainless steel plug is installed in the E-DWT TEST port and that the gland holding the plug is tight.
- ⑦ Slowly lift the reservoir pump handle and then depress at moderate speed with firm, even pressure. With a brief delay, the pressure indicated by the RPM4-E-DWT should rise. If the pressure does not rise above 20 psi (130 kPa), it is likely there is air in the E-DWT hydraulic circuit, most likely in the low pressure PFA tubing between the reservoir and the rest of the system. It is normal for the pressure to drop when the reservoir pump is released since the pump is vented by releasing it.
- ⑧ Close the reservoir shut off valve and check that the test shut off valve is open.
- ⑨ Slowly rotate the variable volume CW and observe the RPM4-E-DWT display. The indicated pressure should increase. Slowly increase the pressure to 1000 psi (7 MPa) and stop. The pressure should decrease, more and more slowly, and eventually stabilize. If the pressure decreases indefinitely (more than 5 minutes), there is probably a leak in the E-DWT and it may require service.
- ⑩ Rotate the variable volume handle CCW to reduce pressure to about 100 psi (700 kPa) and open the reservoir shut off valve.
- ⑪ Put the Lo Q-RPT shut off valve into the Lo Q-RPT Shut Off position (valve rotated fully CW). This isolates the Lo Q-RPT from the E-DWT pressure generation and control system.
Use [RANGE] (see Section 3.7.2) to select the Hi Q-RPT.



If the red CAUTION indicator flashes and/or an audible alarm sounds at any time, immediately reduce pressure to avoid damaging an E-DWT Q-RPT.

- ⑫ Close the reservoir shut off valve and check that the test shut off valve is open.
- ⑬ Slowly rotate the variable volume CW and observe the RPM4-E-DWT display. The indicated pressure should increase. Slowly increase the pressure to 10 000 psi (70 MPa), stop and wait. The pressure should decrease, more and more slowly and eventually stabilize. If the pressure decreases indefinitely (more than 5 minutes), there is probably a leak in the E-DWT and it may require service.
- ⑭ Rotate the variable volume handle CCW to reduce pressure to about 100 psi (700 kPa) and open the reservoir shut off valve.

2.5 SHORT TERM STORAGE

The following is recommended for short term storage (not shipping or transport) of E-DWT-10000-AF:

- Open the reservoir shut off valve.
- Disconnect power.

2.6 LONG TERM STORAGE, PREPARATION FOR SHIPPING

The following is recommended for long term storage and/or shipping of E-DWT-10000-AF:



E-DWT-10000-AF is designed to be shipped with its reservoir full of calibration fluid. If the instructions below are followed carefully, it is not necessary to empty the reservoir prior to shipment.

- **IMPORTANT:** Close the reservoir cover fully by rotating it CW until snug, with reservoir vent valve aligned with CLOSE position.
- **IMPORTANT:** Close the reservoir shut off valve by rotating it CW until snug.
- **IMPORTANT:** Plug the TEST port.
- Remove (by unscrewing) the four variable volume handles on the front of the E-DWT.
- Close the test shut off valve.
- Place the E-DWT-10000-AF in the custom shipping/storage case in which it was delivered.

NOTES



3. OPERATION

3.1 GENERAL OPERATING PRINCIPLES

3.1.1 MULTIPLE RANGES (HI AND LO Q-RPT, AUTORANGE)

The E-DWT-10000-AF's Reference Pressure Monitor (RPM4-E-DWT) has two Quartz Reference Pressure Transducers (Q-RPTs). The A70M (10 000 psi) Q-RPT is designated the **Hi** Q-RPT. The A7M (1 000 psi) Q-RPT is designated the **Lo** Q-RPT. Which Q-RPT is currently active is indicated continuously by characters in the upper right hand corner of the MAIN RUN screen and most other screens.

Each RPM4-E-DWT Q-RPT has a default range which is its maximum range. Additional ranges, lower than the Q-RPT's maximum, may also be created using AutoRange and AutoTest (see Sections 3.7.5, 3.1.3). Ranges created using AutoRange are temporary but may be saved with all their settings for reactivation (see Section 3.8.1).

The ranges available on the RPM4-E-DWT are accessed using **[RANGE]** (see Section 3.7.2) and/or created using **[AutoRange]** (see Section 3.7.5).

An RPM4-E-DWT range is identified by a range screen showing the Q-RPT used by the range, its current unit of measure and its full scale pressure. The range screen is:

1. Q-RPT designator.
2. Type of range. DF for the Q-RPT's default range; AR for a range created by AutoRange.
3. Q-RPT position designator.
4. Current pressure unit of measure.
5. Full scale pressure

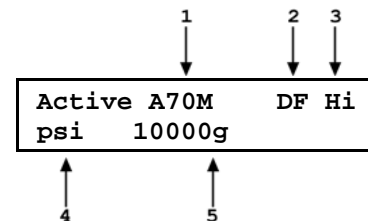

Most settings made in an RPM4-E-DWT range, such as unit of measure, display resolution and stability setting are specific to the range. Settings selected while one range is active apply to that range and not to other ranges. The range specific settings are stored with the range and recalled whenever the range is made active. This makes setting up ranges a convenient way to store and recall frequently used operating configurations. See Table 2 for a listing of RPM4-E-DWT adjustments and settings and whether they are range, Q-RPT or system specific.

Table 2. Settings and what they are specific to (range, measurement mode, Q-RPT, system)

SETTING	PURPOSE	SPECIFIC TO	SECTION
[Unit]	Set pressure unit of measure	Range	3.7.3
[Display]	Set bottom line display function	System	3.7.7
[Head]	Set fluid head correction height, fluid, unit of measure	System	3.7.8
[SDS]	Not used in this RPM4-E-DWT model	Not used	None
[AutoZ]	Run AutoZ	Q-RPT and measurement mode	3.7.10
Resolution	Set pressure display resolution	Range	3.8.2
Stability	Set <i>Ready/Not Ready</i> stability test.	Range	3.8.3
Upper Limit	Set upper and lower pressure limit alarm	Range and measurement mode	3.8.4
AutoZ	AutoZ, ON/OFF, set and view values	Q-RPT and measurement mode	3.9.1
Screen Saver, Sound, Time, ID, Level	Set system user preferences	System	3.9.5
Cal	Various Q-RPT and barometer calibration functions, including turning off absolute and negative gauge modes	Q-RPT or barometer	5.2.2

3.1.2 PRESSURE READY/NOT READY

There is a *Ready/Not Ready* indicator LED on the RPM4-E-DWT front panel to the left of the display. It is intended to provide the user with a clear and objective indication of when a stable pressure has been achieved. *Ready* is indicated when the current stability (rate of change) of pressure is less than the stability limit. The user can set the stability limit (see Section 3.8.3) or the stability limit can be set automatically by a AutoRange or AutoTest (see Sections 3.7.5, 3.1.3). The *Ready* indication is often used when comparing the RPM4-E-DWT and a test device to indicate when a valid reading can be made.

The *Ready/Not Ready* LED indications are:

- <Green > Pressure **Ready** The pressure stability is within the stability limit.
- <Red> Pressure **Not Ready** The pressure stability is NOT within the stability limit.

The default stability criterion is 0.01% of full scale of the active range per second.

3.1.3 AUTOMATED TEST AND CALIBRATION SEQUENCES

The RPM4-E-DWT AutoTest function supports “Quick” and “File” automated calibration sequences. These automatically AutoRange the RPM4-E-DWT, setting its resolution, stability limit and upper limit based on the characteristics of the device under test. They also prompt the user through the increments of the calibration sequence and log calibration data. The AutoTest function should be used for most common calibration tasks, especially calibration of analog pressure gauges.

3.1.4 TYPICAL OPERATING SEQUENCE TO RUN A TEST

The typical operating sequence to run a test is as follows:

- ❶ AutoZero the RPM4-E-DWT:
 - Disconnect the E-DWT TEST port.
 - Close the reservoir shut off valve.

Press [AutoZ] on the RPM front panel (see Section 3.7.10).

- ② Connect the system under test/DUT to the E-DWT TEST port.
- ③ Use [HEAD] to enter the fluid head correction for the difference in height between the E-DWT TEST port and the DUT reference level if significant (see Section 3.7.8).
- ④ Fill and prime the system under test/DUT (see Section 3.5.1):
 - Open the test system/DUT at the highest point possible.
 - Use the filling and priming pump to fill the test system.
 - Close the test system/DUT when all air has been purged.
- ⑤ Use [AutoRange] (see Section 3.7.5) or [AutoTest] (see Section 3.1.3) to set up the RPM4-E-DWT for the test to be run.
- ⑥ Set zero gauge pressure to the DUT by opening the reservoir cap vent valve, the reservoir shut off valve and the TEST shut off valve. The RPM4-E-DWT indication may not be zero if the DUT reference height is different from the E-DWT reference height.
- ⑦ Set the next pressure. Close the reservoir shut off valve. Check that the TEST shut off valve is open. Use the variable volume and fine adjustment valve to set pressure as needed (see Sections 3.5.2, 3.5.3).
 - When the DUT is stable, read the reference pressure applied from the RPM4-E-DWT.
- ⑧ After the last pressure, return to zero by opening the reservoir shut off valve. The RPM4-E-DWT indication may not be zero if the DUT reference height is different from the E-DWT reference height.

3.2 TEST PORT CONNECTION

A single, high pressure TEST port is provided on the top of the E-DWT.

The test port connection is a DH500 F. DH500 is a gland and collar type fitting for 1/4 in. (6 mm) coned and left hand threaded tube. DH500 is equivalent to AE F250C, HIP HF4, etc.

The E-DWT-10000-AF system is delivered with two adaptors to adapt the DH500 F TEST port fitting to 1/4 in. NPT F or 1/8 in. NPT F.



USE THE CORRECT PRESSURE CONNECTORS: The E-DWT TEST port fitting is a DH500 F (see Section 1.2.1). It is NOT a 1/8 in. NPT F. Never use a fitting other than the corresponding male fitting in these connectors. Damage to the connectors and dangerous failure under pressure could result from using incorrect fittings.



DO NOT APPLY PRESSURE UNTIL YOU ARE FAMILIAR WITH OPERATION: The E-DWT-10000-AF TEST port can connect internally to both the RPM4-E-DWT's 1 000 psi (7 MPa) and 10 000 psi (70 MPa) Q-RPTs. The LO Q-RPT SHUT OFF valve on the front of the E-DWT isolates the low pressure Q-RPT when the high pressure Q-RPT is in use. Do not apply pressure to the E-DWT until you are familiar with its operation and know how to protect the low pressure Q-RPT from overpressure (see Section 3.4). FAILURE TO PROTECT THE LOW PRESSURE Q-RPT FROM OVERPRESSURE MAY DESTROY IT. DAMAGE DUE TO Q-RPT OVERPRESSURE IS NOT COVERED BY THE PRODUCT WARRANTY.

3.2.1 RPM4-E-DWT ATM PORTS

The ATM ports on the RPM4-E-DWT Q-RPT modules are connected to the RPM4-E-DWT's internal barometer to assure that the RPM4-E-DWT gauge pressure measurements are relative to ambient pressure. These ports should always be left completely unobstructed and open to atmosphere.

 **NEVER** plug, obstruct or connect a supply pressure to the RPM4-E-DWT Q-RPT module ATM ports. This may adversely affect operation and AutoZeroing functions.

3.3 BATTERY/CHARGER PACK

E-DWT-10000-AF is delivered with two (2) 12 VDC battery/charger packs to supply power to the E-DWT's reference pressure monitor.

The battery/charger pack combines a battery and battery charger.

To Charge the Battery

To charge the battery, connect the battery/charger pack to a 100 to 240 V, 50/60 Hz power supply using the supplied power cable and turn on the charger power switch. The green CHARGE indicator light goes on to indicate that battery charging is in progress. Allow 14 to 16 hours for the battery to charge fully.

When the battery charger power switch is in the ON position, the battery is connected to the charger, not the 12VDC output. When the battery charger switch is in the OFF position, the CHARGE indicator light goes off, and 12VDC battery output is supplied to the 12VDC connection.

The battery may be charged while the battery/charge pack is connected to the RPM4-E-DWT.

 **To preserve battery life, if run the battery down completely before recharging it and do not charge more than 16 hours. Do not leave power connected to the battery continuously.**

To Use the Battery/Charger Pack to Supply the RPM4-E-DWT

After charging the battery, connect the 12VDC connection of the battery/charger pack to the 12VDC connection on the E-DWT rear panel.

Turn the battery/charger pack power switch to OFF (when AC power is connected to the battery/charger pack, the power switch must be OFF for 12VDC power to be output).

To Check the Battery Charge Level

To check the current charge level of the battery, press the BATTERY CHECK toggle switch on the battery/charger pack front panel. Observe the BATTERY CHECK indicator lights. All three lights are lit when battery is fully charged. If no light or one light is on, the battery should be recharged.

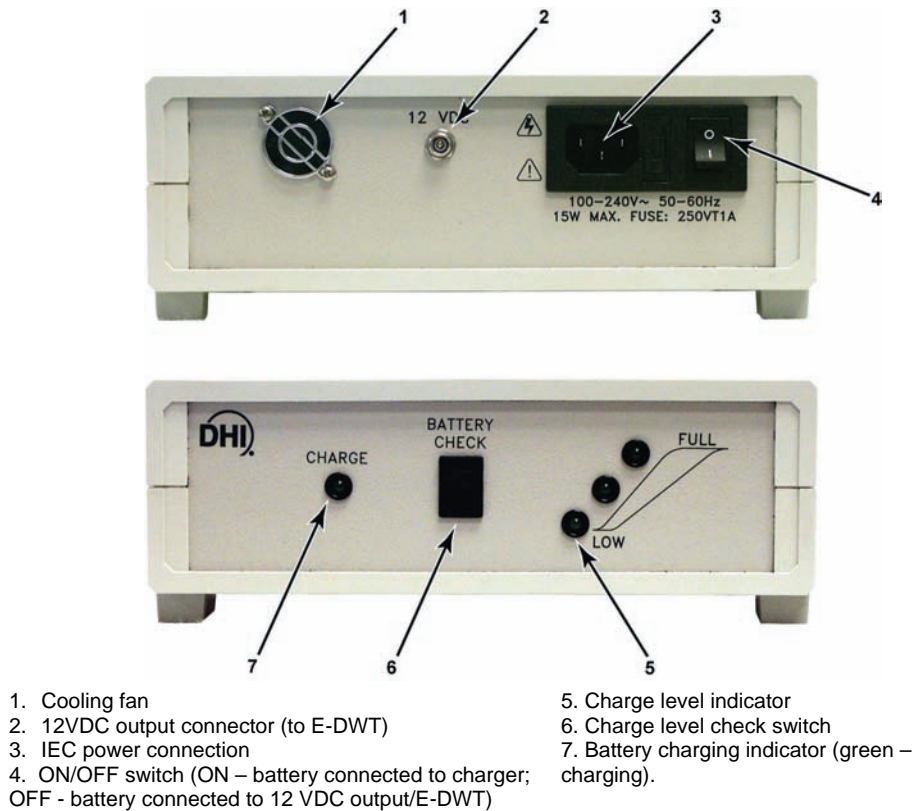

Figure 8. Battery pack/charger

3.4 SELECTING THE HI OR LO Q-RPT

Selection of the active Q-RPT in the RPM4-E-DWT is made using the RPM4-E-DWT front panel's **[RANGE]** key and E-DWT LO Q-RPT SHUT OFF valve.

When the Hi Q-RPT is active, the Lo Q-RPT must be isolated from the E-DWT's pressure generation and control system to avoid destroying it by overpressure.

The E-DWT's Lo Q-RPT shut off valve and visual and audible indicators, assist the operator in performing the correct operations to shut off and protect the Lo Q-RPT when the Hi Q-RPT is in use.

○ OPERATION

See Figure 10 for an E-DWT schematic.

Numerical references in this Section refer to Figure 9.

The Lo Q-RPT is connected to or shut off from the rest of the E-DWT by the Lo Q-RPT shut off valve that is operated using the valve knob. The proper valve position for the Q-RPT selected is prompted by the **Valve Position LEDs** (7, 9).

The Lo Q-RPT shut off valve (8) isolates and protects the Lo Q-RPT from the **TEST** port when it is closed (knob fully CW) and opens the Lo Q-RPT to the **TEST** port when it is open (knob fully CCW).

The Valve Position LEDs (7, 9) indicate the position in which the valve knob should be set based on the current Q-RPT selection on the RPM4-E-DWT. If the Hi Q-RPT is selected, the **LO Q-RPT SHUT OFF LED** (7) is lit indicating that the valve knob should be turned fully CW to close the valve, protecting the Lo Q-RPT from high pressure. If the Lo Q-RPT is selected, the **LO Q-RPT ACTIVE LED** (9) is lit indicating that the valve knob should be turned fully CCW to open the valve, connecting the Lo Q-RPT to the test pressure.

 The E-DWT Lo Q-RPT shut off valve (8) must always be in the closed position (knob fully CW) when operating at pressure greater than 1 000 psi (7 MPa).

The **CAUTION LO Q-RPT ACTIVE** LED (10) is used to indicate that the Lo Q-RPT is active and provide an alert when the Lo Q-RPT is active but a Hi Q-RPT range is selected on the RPM4-E-DWT.

The **CAUTION LO Q-RPT ACTIVE** LED (10) is driven by the value of pressure currently measured by the Lo Q-RPT, it is not driven by the valve position as there is no sensing of the valve position.

The **CAUTION LO Q-RPT ACTIVE** LED (10) has three possible conditions:

- LED is OFF: The Lo Q-RPT is NOT active. The Lo Q-RPT is considered active when it measures a pressure greater than about 100 psig (700 kPa).
 - LED ON continuously: The Lo Q-RPT IS active (exposed to pressure greater than 100 psi) and the Lo Q-RPT is selected on the RPM4-E-DWT. The LED is lit as a reminder that the Lo Q-RPT is active and pressure over its maximum working pressure of 1 000 psi (7 MPa) should not be applied.
 - LED is flashing ON/OFF accompanied by high frequency beeps and <!!LO Q-RPT ACTIVE!!> displayed by RPM4-E-DWT: Lo Q-RPT IS active and the Hi Q-RPT is selected on RPM4-E-DWT. The Lo Q-RPT should NOT be exposed to pressure when the Hi Q-RPT is selected. Exposing the Lo Q-RPT to pressures for which the Hi Q-RPT is normally used, will overpressure and damage the Lo Q-RPT. Vent pressure from the RPM4-E-DWT and shut off the Lo Q-RPT with the Lo Q-RPT shut off valve before continuing to use the Hi Q-RPT.
-

 If the Hi Q-RPT is selected with the Lo Q-RPT active, RPM4-E-DWT goes into an alarm condition to avoid accidental overpressure of the Lo Q-RPT while using a Hi Q-RPT. The pressure on the Lo Q-RPT must be reduced to less than 100 psig (700 kPa) so that the CAUTION LO Q-RPT ACTIVE LED is OFF before shutting the Lo Q-RPT shut off valve and selecting the Hi Q-RPT.

The E-DWT pressure relief valve (Figure 10, Ref 7) is set to open at 150% of the RPM4-E-DWT Lo Q-RPT maximum range. When the pressure applied to the Lo Q-RPT reaches approximately 1 500 psi (10 MPa), the pressure relief valve will open exhausting oil to the reservoir and reducing pressure. Prior to opening the pressure relief valve, the RPM4-E-DWT will have gone into an overpressure condition (see Section 3.8.4.1). If an overpressure condition occurs, reduce pressure as soon as possible. The pressure relief valve will reseal automatically and close when pressure is reduced.

 Do NOT overpressure the Lo Q-RPT. The Lo Q-RPT may be damaged beyond repair by pressure greater than 1 300 psi (9 MPa). Q-RPT damage from overpressure is logged in user and factory maintenance pages and is not covered by the product warranty. The E-DWT pressure relief valve should only be considered a last resort means of protecting the Lo Q-RPT. Following proper operating procedures, the Lo Q-RPT should never be over pressured.



- | | |
|---|--|
| 1. TEST port (DH500F) | 8. Lo Q-RPT shut off valve |
| 2. Reservoir cap vent valve | 9. 'Lo Q-RPT active' valve position prompt LED |
| 3. Priming pump | 10. 'Lo Q-RPT active' caution indicator |
| 4. Reservoir cap | 11. Reservoir shut off valve |
| 5. Reference pressure monitor (RPM4-E-DWT) | 12. Variable volume (pressure generation) |
| 6. Test shut off valve and fine pressure adjustment | 13. Variable volume piston position indicator |
| 7. 'Lo Q-RPT shut off' valve position prompt LED | |

Figure 9. E-DWT-10000-AF front view

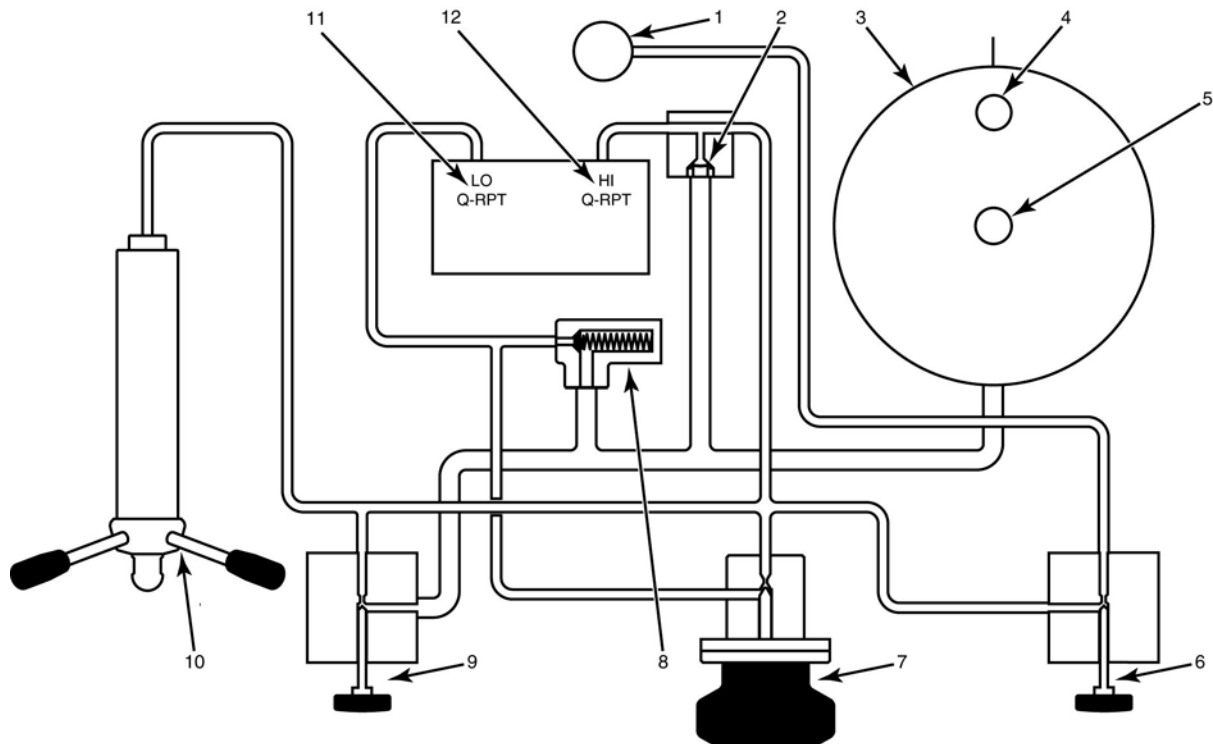

- | | | |
|---------------------------------|--|--|
| 1. TEST port | 5. Priming pump | 9. Reservoir shut off valve |
| 2. System pressure rupture disc | 6. Test shut off and fine adjustment valve | 10. Variable volume |
| 3. Reservoir | 7. Lo Q-RPT shut off valve | 11. Lo Q-RPT (ref pressure transducer) |
| 4. Reservoir vent valve | 8. Lo Q-RPT pressure relief valve | 12. Hi Q-RPT (ref pressure transducer) |

Figure 10. E-DWT-10000-AF hydraulic schematic

3.5 PRESSURE GENERATION AND ADJUSTMENT

E-DWT-10000-AF has three means for generating and adjusting pressure, including filling and priming the test system.

The reservoir pump is used to fill and prime the test system (see Section 3.5.1). It is important to remove air from the test system by filling and priming it before using the variable volume to generate pressure. Failure to fill and prime will result in the need to use multiple variable volume strokes to generate pressure.

The variable volume is used for pressure generation and rough pressure adjustment (see Section 3.5.2).

The test shut off and fine adjust valve are used for fine pressure adjustment (see Section 3.5.3).

3.5.1 FILLING AND PRIMING, RESERVOIR PUMP

It is important to remove air from the test system by filling and priming it before using the variable volume to generate pressure. Failure to fill and prime will result in the need to use multiple variable volume strokes to generate pressure.

The reservoir pump is designed to push oil through the E-DWT and out the TEST port into the test system. It can also be used to generate an initial pressure, saving variable volume stroke.

To fill and prime the test system, prior to generating pressure with the variable volume, proceed as follows:

See Figure 9 and Figure 10 for an E-DWT schematic and view when following this procedure.

- ❶ Leave an open purge point (for example a loose fitting) at the highest point possible in the test system that is connected to the E-DWT.
- ❷ Open the reservoir shut off valve to connect to reservoir from the test system.
- ❸ Position the reservoir cap correctly by rotating it CW until the reservoir vent valve is at the CLOSE position. Do not overtighten, do not CW beyond CLOSE position.
- ❹ Be sure that the reservoir cap vent valve is open (loosened CCW).
- ❺ If not already open, open the TEST shut off valve to connect the E-DWT to the test system.
- ❻ Pull the reservoir handle pump up slowly to fill it with oil from the reservoir. Then push the handle down firmly with moderate speed to seal the tip of the pump against the reservoir seat and inject oil into the E-DWT and out the TEST port.
- ❼ Repeat ❻ while observing the open purge point in the test system. When only oil and no air comes out of the purge point, close and tighten the purge point.
- ❽ If desired, repeat ❻ to set an an intial pressure with the reservoir pump. Be sure the variable volume is already filled and in the start position (Section 3.5.2, ❶ - ❷), and the reservoir shut off valve is open.

Press down on the pump handle but do not release your downward force when the pump gets to end of stroke or becomes to difficult to push down. While maintaining the downward force on the pump handle, close the reservoir shut off valve to capture the priming pressure.



Do not attempt to generate greater than 100 psi (700 kPa) using the reservoir priming pump.

- ⑨ Once the system is filled and primed, use the variable volume to generate pressure to the desired pressure set point (see Section 3.5.2).

 When the reservoir cap vent valve is closed, the reservoir is not connected to atmosphere so opening the reservoir shut off valve and the test shut off valve may not fully vent the DUT. To be sure the DUT is fully vented to atmosphere, OPEN the reservoir cap shut off valve and/or disconnect at the TEST port.

3.5.2 PRESSURE GENERATION AND ROUGH ADJUSTMENT, VARIABLE VOLUME

 The variable volume can generate very high pressure very quickly. When using the variable volume, use caution not to generate pressure more quickly than desired and not to exceed the pressure rating of the E-DWT, it's Q-RPTs or any component of the test system to which it is connected.

The variable volume is used to accomplish large pressure changes and to roughly adjust pressure at a set point. It can generate high pressure with relatively little effort.

The variable volume is not designed to fill and prime the test system. To avoid needing to refill the variable volume to reach the desired pressure, use the reservoir pump to fill and prime the test system before going to the variable volume (see Section 3.5.1).

To generate and adjust pressure with the variable volume proceed as follows:

See Figure 9 and Figure 10 for an E-DWT view and schematic when following this procedure.

- ❶ Open the reservoir shut off valve to connect the reservoir to the variable volume.
Close the TEST shut off valve to avoid 'pulling' oil out of the test system in step ❷.
- ❷ Rotate the variable volume CCW until the piston position indicator is at the beginning of its stroke (indicator white).
- ❸ Close the reservoir shut off valve to shut off the reservoir from the variable volume.
- ❹ Open the TEST shut off valve to connect the variable volume to the test system.
- ❺ Check that the RPM4-E-DWT Q-RPT selection and Lo Q-RPT shut off valve setting are correct for the pressure range.
- ❻ While carefully watching the pressure indicated on the RPM4-E-DWT, rotate the variable volume CW to increase pressure to the desired set point. Using the variable volume, it should be easy to adjust the set pressure within 100 psi (700 kPa). To adjust pressure more finely than is possible with the variable volume, use the fine adjust valve (see Section 3.5.3).
- ❼ If the variable volume runs out of stroke (piston position indicator red and variable volume will not rotate CW further) before the desired set pressure is reached, the variable volume can be isolated from the TEST port and refilled to continue generating pressure (see 8.).
- ❽ To refill variable volume while the test system is under pressure proceed as follows:
 - Ⓐ Close the TEST shut off valve.
 - Ⓑ Record the pressure indicated by the RPM4-E-DWT. You will need to reset this pressure to minimize the change in test pressure when you reconnect the refilled variable volume to the test system
 - Ⓒ Slowly open the reservoir shut off valve.

- Ⓒ Rotate the variable volume CCW to the beginning of its stroke (position indicator white, variable volume will no longer rotate).
- Ⓔ Close the reservoir shut off valve.
- Ⓕ Rotate the variable volume CW to generate pressure until the pressure reaches the value recorded in step a. Use only the variable volume to adjust the pressure.
- Ⓖ Slowly open the TEST shut off valve to reconnect the variable volume to the test system. Proceed to continue to generate pressure as in 6.
- Ⓗ To reduce pressure, rotate the variable volume CCW.

 *Opening the reservoir shut off valve while the E-DWT is under pressure will very rapidly drop the pressure. Generally, it is not recommended to drop the pressure applied to pressure measuring devices very rapidly. To reduce pressure slowly, use the variable volume and only open the reservoir shut off valve to open the system to atmosphere.*

3.5.3 PRESSURE FINE ADJUSTMENT, FINE ADJUST VALVE

To adjust pressure more precisely than is possible with the variable volume, the fine adjust valve is used. When the valve is open, the displacement of its needle is used as a miniature variable volume to adjust pressure.

The test isolation and fine adjust valve is a needle valve with a stroke of several millimeters. Turn the valve handle CW to increase pressure CCW to decrease.

When using the fine adjust valve to adjust pressure, be sure not to close the valve so that the E-DWT is no longer connected to the test system. If turning the valve handle or the variable volume does not change the pressure indicated by both the RPM4-E-DWT AND the device under test, the valve is closed.

3.6 RPM4-E-DWT USER INTERFACE

The E-DWT-10000-AF's RPM4-E-DWT A70M/A7M-AF reference pressure indicator is designed to offer the optimum balance between simple, straight forward operation and the availability of a wide variety of functions with a high level of operator discretion if desired.

The RPM4-E-DWT's local operator interface is through the front panel's 2 x 20 character alpha-numeric display, a function/data keypad, a cursor control pad and a *Ready/Not Ready* indicator. An optional **[ENTER]** footswitch is available. Remote communication is also available via the RS-232 (COM1) interface (see Section 4).

The E-DWT mounts the RPM4-E-DWT at a convenient viewing angle and includes a valve and visual indicators to isolate and protect the RPM4-E-DWT's 1 000 psi Q-RPT (A7M) when using the 10 000 psi Q-RPT (A70M) (see Section 3.4).

3.6.1 MAIN RUN SCREEN

The RPM4-E-DWT MAIN RUN screen is its home display that is reached on power-up and from which other functions and menus are accessed. It is the very top level of all menu structures.

The MAIN RUN screen is where RPM4-E-DWT is left in normal operation. It displays the current measured pressure as well as a variety of additional information if desired.

Figure 11 and its legend summarize the RPM4-E-DWT MAIN RUN screen fields and their functions.

 RPM4-E-DWT has a screen saver function which causes the display to dim if no key is pressed for 10 minutes. Pressing a key restores full power to the display. The screen saver time can be changed or screen saving can be completely suppressed (see Section 3.9.5.1).

PRESSURE1UNITM hzRR
DDISPLAYFUNCTIONnn / nn

DISPLAY FIELD	NAME	PURPOSE	CONTENTS	SECTION
1. PRESSURE1	Measured pressure	Displays pressure measured by the active Q-RPT	Numerical pressure value and sign.	1.2.3
2. UNIT	Unit of measure	Identifies unit of measure in which pressure values are displayed	Pressure unit abbreviation	3.7.3
3. M	Measurement mode	Not used in the E-DWT-AF RPM4-E-DWT. RPM4-E-DWT supports gauge mode only.	<g > for gauge mode	None
4. h	Head pressure indicator	Indicates whether a fluid head correction is applied to PRESSURE1	<h> the fluid head is not zero <blank> fluid head is zero	3.7.8
5. z	AutoZero indicator	Indicates whether the AutoZero function is ON or OFF for the active Q-RPT and measurement mode	<z> AutoZ is ON <blank> AutoZ is OFF	3.9.1
6. RR	Active Q-RPT position indicator	Indicates the position of the active Q-RPT in the RPM4-E-DWT	<Hi> Hi Q-RPT <Lo> Lo Q-RPT	3.1.1
7. nn/nn	Sequence progress indicator	Indicates progress of AutoTest sequence, during test execution	<NN/NN> Number of this point over total number of points in the sequence	3.1.3,
8. DISPLAY FUNCION	Information specific to the DISPLAY mode	Pressure indication depending on current RPM4-E-DWT DISPLAY function. Leading character identifies the value	Numerical pressure value and sign. <PPC EXT DEV:> when the RPM4-E-DWT is initialized as an external device to a PPC pressure controller.	3.7.7
9. D	Pressure information indicator	Pressure information indicator depending on current RPM4-E-DWT DISPLAY function.	<σ> Display mode is AVERAGE and value is standard deviation <R> Display mode is RATE and value is pressure rate of change per second <H> Display mode is HI/LO and value is high, then low <D> Display mode is DEVIATION and value is difference from current target <*, ↑, ↓ > Display mode is Q-RPT and value is measurement of inactive Q-RPT <F> Display mode is FREEZE and value is last captured reading Blank, no character Current display mode is CLEAN	3.7.7

Figure 11. MAIN RUN screen display fields

3.6.2 FUNCTION / DATA KEYPAD LAYOUT AND PROTOCOL

The RPM4-E-DWT has a function/data keypad for local operator access to direct functions, function menus and for data entry.

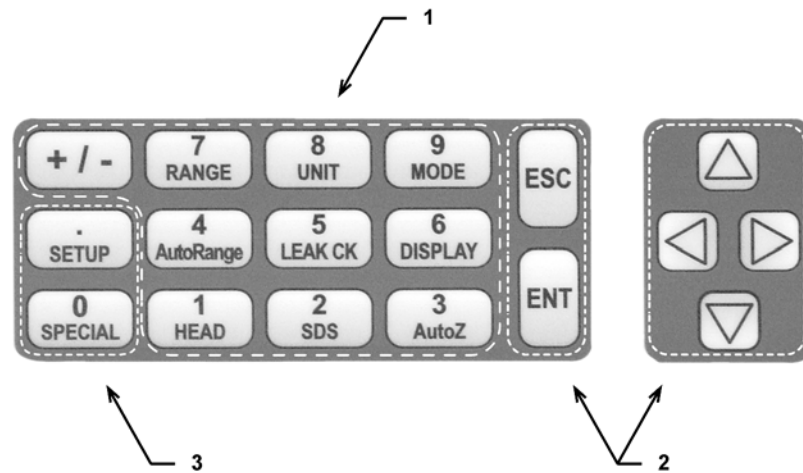

1. The **Function/Data keys** allow very commonly used functions to be accessed directly by a single keystroke when pressed from the MAIN RUN screen (see Section 3.6.1). The name of the function is on the bottom half of the key. These keys enter numerical values when editing.
2. The **Editing and Execution keys** are for starting and suspending command execution, cursor control in menus and editing entries.
3. The **Menu/Data keys** provide access to function menus when pressed from the MAIN RUN screen. The menu name is on the bottom half of the key. The SETUP menu is for more frequently used functions (see Section 3.8). The SPECIAL menu is for functions that are not generally used as a part of day to day operation (see Section 3.9). These keys enter numerical values when editing.

Figure 12. Keypad layout

Pressing **[ENT]** generally causes execution or forward movement in the menu tree.

Pressing **[ESC]** moves back in the menu tree and/or causes execution to cease or suspend. Pressing **[ESC]** repeatedly eventually returns to the MAIN RUN screen and, from there, allows momentary viewing of the RPM4-E-DWT introduction screen.

Pressing the **[+/-]** key changes a numerical sign when editing. It also toggles through multiple screens when available and, from some run screens, is a shortcut to a momentary display of active RANGE.

Pressing the **[▲]**, **[▼]**, **[◀]** and **[▶]** keys allows up, down, reverse and forward cursor movement when editing data **entry** or moving in menus.

 *Some screens go beyond the two lines provided by the display. This is indicated by a flashing arrow in the second line of the display. Press the cursor control keys to move the cursor to access the lines that are not visible or directly enter the number of the hidden menu choice if you know it.*

3.6.3 OPTIONAL REMOTE [ENT] (ENTER) FOOTSWITCH

Operating the footswitch is the equivalent of pressing **[ENT]** on the front panel.

The remote ENTER feature can be particularly convenient when running AutoTests (see Section 3.1.3) in which the operator's hands are not free or attention is on the device under test rather than the RPM4-E-DWT.

3.6.4 SOUNDS

RPM4-E-DWT is equipped with a variable frequency tone device to provide audible feedback and alarms. The beeper is used for the following indications.

Valid key press	Brief beep. Choice between three frequencies or NO sound is available (see Section 3.9.5.2).
Invalid key press	Descending two tone “blurb”
Change E-DWT Lo Q-RPT shut-off valve setting	Four one second beeps (see Section 3.4).
Leak check completed	Three two second beeps (see Section 3.7.6).
Upper limit exceeded	Intermittent one second beeps (see Section 3.8.4).
Pmax! (overpressure limit) exceeded	Eight second high frequency beep (see Section 3.8.4.1).
AutoTest in/out of tolerance reading	Ascending triad/descending triad (see Section 3.7.11).
Hi Q-RPT is selected but Lo Q-RPT is being pressurized	Intermittent two second high frequency beep. The audible alarm is combined with flashing of the red, Lo Q-RPT Active LED on the E-DWT (see Section 3.4, 3.7.2).
AutoTest in/out of tolerance reading	Ascending triad/descending triad (see Section 3.7.11).

3.7 RPM4-E-DWT DIRECT FUNCTION KEYS



3.7.1 SUMMARY

 *Table 3 provides a brief summary of RPM4-E-DWT direct function key operation. It may be useful to keep a copy of this summary near the E-DWT, especially when first becoming acquainted with its operation.*

Local operation of RPM4-E-DWT is through the front panel keypad. To minimize multi-layered menu structures, the keypad numerical keys also provide direct access to the most commonly used functions. The function accessed is labeled on the bottom half of the key. Direct function keys are active whenever RPM4-E-DWT is in its MAIN RUN screen. Table 3 summarizes the operation of the direct function keys.

Table 3. Summary of RPM4-E-DWT function key operation

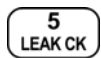
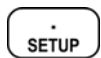
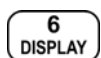
DIRECT FUNCTION KEYS ARE ACTIVE FROM THE MAIN RUN SCREEN			
See corresponding manual sections for full detail.			
1 HEAD	Adjust height of fluid head correction. Set to zero to defeat correction.	7 RANGE	View active range and toggle through available ranges. [ENT] on a range activates it.
2 SDS	Feature not used in RPM4-E-DWT.	8 UNIT	Select pressure unit of measure for the active range. Choice of units available in this menu can be customized.
3 AutoZ	Run the AutoZ function to AutoZero the active Q-RPT.	9 MODE	Not used. E-DWT-AF RPM4-E-DWT is gauge mode only.
4 AutoRange	Set up and optimize RPM4-E-DWT features for a specific operating range.	0 SPECIAL	Menu of less commonly used internal functions and settings.

	Run automated leak checking routine.		Menu of commonly used setup features including save/delete AutoRange ranges, set display resolution, set stability limit, set upper/lower limit, view AutoTest data
	Select the display function for the bottom line of the RPM4-E-DWT display.		Start or set functions such as Leak Check, AutoTest and Freeze. ENTER values when editing.

3.7.2 [RANGE]

○ PURPOSE

To view and/or change the active pressure measurement range and associated settings.

○ PRINCIPLE

An RPM4-E-DWT range is defined as a pressure span and associated settings (see Section 3.1.1).

The RPM4-E-DWT has two Q-RPTs. Each Q-RPT has a default range which is its maximum span. The default ranges of the RPM4-E-DWT A70M/A7M-AF are 10 000 psi (A70M) and 1 000 psi (A7M). Additional ranges, lower than the Q-RPT's maximum span, may be created at any time using AutoRange (see Section 3.7.5) or AutoTest (see Section 3.1.3). Ranges created using AutoRange or AutoTest may be saved, with their settings, for reactivation (see Section 3.8.1).

The [RANGE] function key allows the available RPM4-E-DWT pressure ranges to be viewed and selected.

○ OPERATION

Pressing the [RANGE] function key activates the range viewing and selecting function. When the [RANGE] function key is first pressed, the active range is displayed. For example:

1. Q-RPT designator.
2. Type of range. DF for the Q-RPT's default range; AR for a range created by AutoRange.
3. Q-RPT position designator.
4. Current pressure unit of measure.
5. Full scale pressure in current unit of measure .

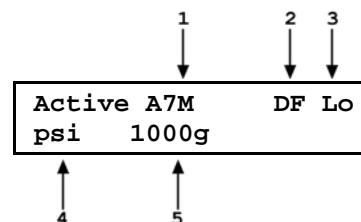

Pressing the [RANGE] key again while in the RANGE functions toggles through displays of the other available ranges, from lowest range to highest range.

To select a range to become the active range, press [ENT] while the range is displayed.

Any time a range change causes the active Q-RPT to change, the E-DWT Lo Q-RPT shut off valve must be operated to connect or disconnect the Lo Q-RPT from the TEST port. The green Lo Q-RPT valve position LEDs indicate the correct position of the Lo Q-RPT shut off valve knob based on the Q-RPT currently in use (see Section 3.4).

Pressing [ESC] while in the RANGE function returns to the MAIN RUN screen without making a range change.

 The E-DWT Lo Q-RPT shut off valve protects the Lo QRPT (1 000 psi max) from overpressure when the Hi Q-RPT is in use. Familiarize yourself with E-DWT operation (see Section 3.4) before changing ranges and applying pressures. Always turn the Lo Q-RPT shut off valve fully in the direction of the lighted green LED before applying pressure.



Range full scale limits are given in the pressure unit that is currently active for that range.



Pressing [+/-] from the MAIN RUN screen provides a shortcut to a momentary view of the active range.



Many RPM4-E-DWT settings and functions are range specific. See Table 2 for identification of range specific settings.



For best metrological performance, vent the RPM4-E-DWT Q-RPT before changing ranges.

3.7.3 [UNIT]

○ PURPOSE

To select the unit of measure in which RPM4-E-DWT displays pressure values.

○ PRINCIPLE

RPM4-E-DWT allows the unit of measure in which pressure values are displayed to be changed.

RPM4-E-DWT A70M/A7M-AF supports 13 standard pressure units of measure as well as user defined units. To simplify operation, quick access to up to six units is made available under the [UNIT] key. The [UNIT] key contents can be customized by the user to any configuration of six units (see Section 3.9.6).



Internally, RPM4-E-DWT always operates in Pascal (Pa), the SI unit of pressure. Values of pressure are represented in other units by the application of conversion factors to convert from Pa (see Section 7.1.1).

○ OPERATION

See Figure 9 and Figure 10 for an E-DWT view and schematic when following this procedure.

- ❶ To change the active pressure unit of measure for a range, press [UNIT] from the MAIN RUN screen while the range is active. The display is:

1psi	2MPa	3kPa
4bar		
- ❷ The cursor is on the number corresponding to the active pressure unit of measure for the active range.
- ❸ To change the pressure unit of measure, select the desired unit. Making the selection returns to the MAIN RUN screen with the selected unit active.



The pressure unit of measure selected is range specific. When in a given range, all functions and settings are represented in the current measurement unit for that range. However, certain internal and/or metrological functions (e.g., Q-RPT calibration coefficients) are always represented in Pa regardless of the current range unit.



See Section 7.1.1 for tables of the conversion factors used by RPM4-E-DWT.



If the pressure unit selected is inWa (inches of water), the reference temperature for water density must be specified in a separate menu (choices are 4°C, 20°C 60°F). No reference temperature selection is necessary for the unit mmWa as the only reference temperature commonly used for mmWa is 4 °C.



The choice of up to six units available under the UNIT function can be customized from a wider selection by the user (see Section 3.9.6). The units available under the UNIT function can be reset to default by reset (see Section 3.9.9.2).

3.7.4 [MODE]

○ PURPOSE

Not used in E-DWT-10000-AF's RPM4-E-DWT A70M/A7M-AF. Measurement mode is always gauge (difference from atmospheric pressure).

3.7.5 [AUTORANGE]

○ PURPOSE

To automatically set up the RPM4-E-DWT to optimize its measurement characteristics and features for a specific, user defined pressure range of operation.

○ PRINCIPLE

RPM4-E-DWT A70M/A7M-AF is designed to support the calibration and test of a very wide variety of test ranges.

The AutoRange function simplifies the task of selecting the Q-RPT best suited to cover a specific test range and setting measurement parameters appropriately for that specific range. These are set automatically based on operator entry of desired measurement mode, pressure unit of measure and range full scale. The selections and settings made by AutoRange are summarized in Table 4.

A range set up using AutoRange and all its range specific settings, may be saved for recall using [SETUP], <1range> (see Section 3.8.1). Saved ranges are available for later selection using [RANGE] (see Section 3.7.2). If a range created by AutoRange is not saved, it is overwritten by the next AutoRange or erased when another range is selected.



Press [ENT] from the main run screen in Rate DISPLAY mode to use the [AutoTest] function to AutoRange the RPM4-E-DWT based on DUT tolerance (see Section 3.7.11).

Table 4. Settings made by AutoRange

SETTING/SELECTION	PURPOSE	SET TO	SECTION
Unit	Set pressure unit of measure	Operator specified during AutoRange	3.7.3
Full scale	Establish span maximum	Operator specified during AutoRange	None
AutoRange span	Basis of span based setting calculations	Zero gauge to AutoRange full scale	None
Q-RPT	Select most appropriate Q-RPT to cover range and mode.	Q-RPT with lowest span whose full scale is greater than AutoRange full scale	1.2.3.1
Upper limit	Set maximum and minimum pressure alarm limits.	105 % of operator entered full scale pressure	3.8.4
Resolution	Set display resolution	0.01% of AutoRange span or 1 ppm of default Q-RPT span, whichever is larger.	3.8.2
Stability Limit	Set Ready/Not Ready stability criterion.	0.01% AutoRange span or 5 ppm of default Q-RPT span, whichever is larger.	3.8.3, 3.7.5

○ OPERATION

To use the AutoRange function, press **[AutoRange]** and respond to the RPM4-E-DWT's prompts.

- ❶ **Select pressure unit of measure:** The screen is identical in appearance and function to the **[UNIT]** screen (see Section 3.7.3).
- ❷ **Enter the AutoRange full scale pressure:** Enter the full scale pressure value in the **<----->** entry field and press **[ENT]**. If the full scale value entered cannot be covered by RPM4-E-DWT, an error message appears.
- ❸ **View proposed AutoRange range:** The proposed AutoRange range screen is:

1. Indication that this is a screen of the proposed AutoRange range.
2. Designator and position of the Q-RPT that AutoRange has selected to cover the AutoRange full scale and measurement mode.
3. Pressure unit of measure specified in AutoRange.
4. AutoRange full scale pressure.

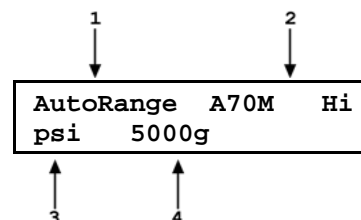

 If AutoRange selects a Q-RPT but you would like to use the other one, the cursor control keys may be used to toggle between Q-RPTs so that the other can be selected.

- ❹ **Accept proposed AutoRange:** To accept the proposed AutoRange and go to the MAIN RUN screen with the new AutoRange range active, press **[ENT]** or **[AutoRange]**. To modify the AutoRange full scale or pressure unit of measure, use **[ESC]** to back through the AutoRange screens and make changes.

 The E-DWT Lo Q-RPT Shut off valve protects the Lo Q-RPT (1 000 psi max) from overpressure when the Hi Q-RPT is in use. Familiarize yourself with E-DWT operation (see Section 3.4) before changing ranges and applying pressures. Always turn the Lo Q-RPT Shut off valve fully in the direction of the lighted green LED before applying pressure.



To verify or confirm the range from the MAIN RUN screen, use [+/-] or [RANGE] to view the active range (see Section 3.7.2).



See Table 4 for a listing of all selections and settings affected by AutoRange and their values.

3.7.6 [LEAK CK]

○ PURPOSE

To run an automated leak check routine that determines the leak rate of the system connected to the E-DWT **TEST** port.

○ PRINCIPLE

The LEAK CHECK function is provided as a means of checking and quantifying the leaks that may be present in the system connected to the E-DWT **TEST** port.

The principle of the LEAK CHECK function is the measurement of the natural decrease or increase of pressure in a fixed volume over time. The LEAK CHECK function allows a leak check time to be set. The total pressure change and the average rate of change over the leak check time are calculated and displayed.

○ OPERATION

To run a leak check, first set the pressure to the desired leak check pressure.



Changing the pressure in a test system causes adiabatic temperature changes in the pressurized medium that need to have dissipated before a valid leak measurement can be made. In general, a 0.5 to 1 minute wait before running a leak check is adequate to allow the adiabatic temperature change to dissipate and valid leak measurements to be made. However, stabilization time may be much longer for large pressure changes and as volume and pressure increase.

To access the LEAK CHECK function, press [**LEAK CHECK**] from the MAIN RUN screen. Select **<1run>** to run a leak test. The display is:

1. Edit field for the time over which the leak rate will be determined, in seconds.

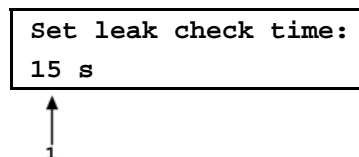

Edit the leak check time if desired (minimum 1, maximum 999 seconds) and press [**ENT**]. Press [**ENT**] again when ready to start the leak test. The leak test display is:

1. Standard MAIN RUN screen first line showing measured pressure.
2. Active Q-RPT position indicator
3. Indication that leak test is running and countdown of time remaining.

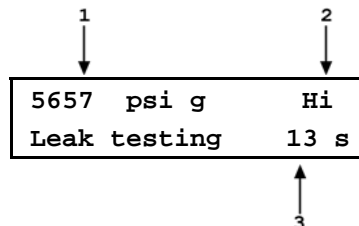

[ESC] can be used to abort the running leak test. **[ENT]** while the leak test is running restarts the leak check timer. When the leak check timer countdown has completed, RPM4-E-DWT beeps three times and the leak check results screen is displayed:

1. Total pressure change from start to finish of leak check time.
2. Indicator of Q-RPT used to run the leak check.
3. Average rate of change of pressure over the leak check time period (ΔP /time in seconds).

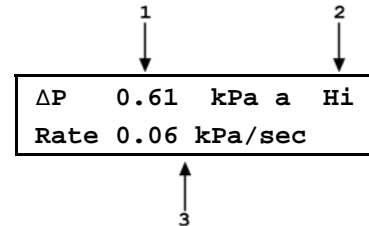

From the leak check results screen, press **[ENT]** to repeat the leak test.

Press **[ESC]** to return to leak check main menu and exit to the MAIN RUN screen.

To view the results of the most recently completed leak check, press **<2view>**. If NO leak check data is stored (i.e., if the RPM4-E-DWT has never run a leak test or a reset has cleared previous leak test results), the results screen displays **<Data NOT available>** briefly and returns to MAIN RUN screen. Press **[ENT]** or **[ESC]** to return to the MAIN RUN screen.



Leak check is range specific in the sense that a leak check is run using the active range. However, only one set of leak check results is maintained in memory and each leak test completed overwrites the memory. View leak check always shows the results of the last leak check run regardless of the range that is now active. The results screen includes the range indicator to indicate the range in which the leak check was run.

3.7.7 [DISPLAY]

○ PURPOSE

To select, from a variety of choices, the information that is displayed on the second line of the RPM4-E-DWT display.

○ PRINCIPLE

RPM4-E-DWT supports a variety of advanced pressure measurement functions that are displayed on the second (bottom) line of the RPM4-E-DWT display. In summary, the available display functions included are:

AVERAGE Calculates the average measured pressure over a user specified period of time and displays the average, the standard deviation about the mean and a countdown in seconds to the next average (see Section 3.7.7.1). This function is often used to filter out pressure noise in an unstable system. The magnitude of the noise is quantified by the standard deviation about the mean. A second Avg screen allows the instantaneous pressure values to be viewed during an averaging cycle.

RATE Calculates and displays the current rate of change of pressure in current pressure units/second (see Section 3.7.7.2). This function is a useful indication of the stability of the pressure being measured. It is often used as an indication of positive or negative leak rate and as a go/no go criterion of when to take data when comparing RPM4-E-DWT and a device under test, for example in a calibration. Rate is used by the Ready/Not Ready function to determine when a Ready condition exists (see Section 3.1.2).

DEVIATION Continuously calculates and displays the difference between the pressure measured by RPM4-E-DWT and a target pressure entered by the user (see Section 3.7.7.3). This function is useful in monitoring the evolution of pressure around and/or away from a desired set point.

- RPT** Allows pressure measurement from the RPM4-E-DWT's two Q-RPTs to be displayed simultaneously (see Section 3.7.7.4).
- HI/LO** Records and displays maximum and minimum pressures measured (see Section 3.7.7.5). This function is used to keep track of the minimum and maximum pressure observed in a system over a period of time or to monitor if a pressure min/max limit has been exceeded.
- FREEZE** Captures and displays the pressure measured by the active range of RPM4-E-DWT when the **[ENT]** key is pressed (see Section 3.7.7.6). This function is useful to record the pressure present at the time of an operator observed trigger event, for example when the needle of an analog gauge is on the nominal point or when a switch activates.
- CLEAN** Blanks out the second line of the display (see Section 3.7.7.7). This function is used when a simple display of pressure measured by the RPM4-E-DWT active range with minimal additional information is desired.

○ OPERATION

To set the DISPLAY function press **[DISPLAY]** from the main run screen.

The display is:

1Avg 2Rate 3Dev 4RPT
5Hi/Lo 6Freez 7Cln

The cursor is on the active DISPLAY function. Selecting a DISPLAY function returns to the main run screen with the selected function active. See Sections 3.7.7.1 to 3.7.7.7 for information on each of the DISPLAY choices.

 *The DISPLAY selection is NOT range specific. A DISPLAY selection made in one range applies to all ranges.*

 *The default DISPLAY function is Rate which causes the second line of the display to show "R" followed by the current rate of change of pressure in current pressure units per second.*

3.7.7.1 AVG (AVERAGE)

○ PURPOSE

To activate the Average DISPLAY and/or adjust the period of time over which averaging occurs.

 *See Section 3.7.7. ○ Principle.*

○ OPERATION

To access the Average DISPLAY, press **[DISPLAY]**, <1Avg>. The display is:

1. Edit field for averaging period in seconds.
Default is 20. Minimum 1, maximum 999.

Averaging Period:
20 s

Edit the averaging time period if desired. Press **[ENT]** to return to the main run screen with the Average DISPLAY active.

With the Average DISPLAY active the main run screen is:

1. Average measured over last completed averaging period.
2. Standard deviation of last completed averaging period.
3. Countdown in seconds until completion of on-going averaging period.

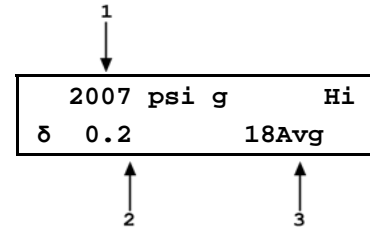

The Average DISPLAY has a second screen that allows the instantaneous pressure readings to be viewed while an averaging cycle is running. The instantaneous Average screen is:

1. Instantaneous pressure values at RPM4-E-DWT's normal update rate.
2. Current rate of change of pressure in pressure units/second.
3. Countdown in seconds until completion of on-going averaging period.

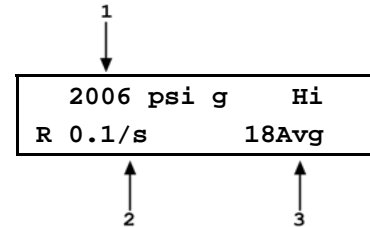

The [+/-] key toggles between the main run Average screen and the instantaneous values Average screen.



Pressing [ENT] while in the Average DISPLAY aborts the current averaging period and causes a new one to begin. [ENT] can thus be used to trigger a new averaging period on demand.



In the Average DISPLAY the Ready/Not Ready indication applies to the result of the previous averaging period (see Section 3.1.2). Ready indicates that all readings during the previous averaging period met the stability criterion. Not Ready indicates that one or more readings were outside of the stability criterion.



Changing the pressure unit of measure, measurement mode or range while the averaging screen is active, starts a new averaging period.



To go to a DISPLAY other than Average, press [DISPLAY] and make a new DISPLAY choice (see Section 3.7.7).

3.7.7.2 Rate

○ PURPOSE

To activate the Rate DISPLAY.



See Section 3.7.7, ○ Principle.



The Rate run screen accesses the AutoTest function (see Section 3.7.11) to AutoRange RPM4-E-DWT based on DUT characteristics. To access AutoTest, press [ENT] from the Rate run screen.

○ OPERATION

To activate the Rate DISPLAY press **[DISPLAY]**, **<2Rate>**. Pressing **<2Rate>** returns to the main run screen with the Rate DISPLAY active.

With the Rate DISPLAY active the main run screen is:

1. Current rate of change of pressure in current pressure unit per second.

8455 psi g	Hi
R 0.1/sec	



The Rate DISPLAY is different and separate from the stability setting which is used to set the stability criterion on which the Ready/Not Ready indication is based (see Sections 3.8.3 and 3.1.2). The Rate DISPLAY only causes the current rate of change to be displayed and has NO effect on the stability setting or the Ready/Not Ready condition.



The Rate DISPLAY is the default RPM4-E-DWT main run screen display.



To go to a DISPLAY other than Rate, press **[DISPLAY]** and make a new DISPLAY choice (see Section 3.7.7).

3.7.7.3 Dev (Deviation)

○ PURPOSE

To activate the Deviation DISPLAY and/or set the deviation target value.



See Section 3.7.7, ○ Principle.

○ OPERATION

To activate the Deviation DISPLAY press **[DISPLAY]**, **<3Dev>**. The display is:

Target:
9000 psi g

Edit the desired target value. Pressing **[ENT]** returns to the main run screen with the Deviation DISPLAY active using the entered target value.



The target value is the value from which deviations (D) are measured by the Deviation DISPLAY following:

$$D = \text{current pressure} - \text{target pressure}$$

With the Deviation DISPLAY active the main run screen is:

1. Deviation of current pressure from the target value.
2. Target value.

8998	psi a	zH3
D -2	T9000.0	



Pressing [ENT] from the main run screen when the Deviation DISPLAY is active goes directly to the Target editing screen. This allows the target value to be changed and without going through the DISPLAY menu.



If the pressure measurement unit or mode is changed while the Deviation DISPLAY is active the target value remains at the same numerical value. It is NOT converted.



To go to a DISPLAY other than Deviation, press [DISPLAY] and make a new DISPLAY choice (see Section 3.7.7).

3.7.7.4 RPT

○ PURPOSE

To activate the Q-RPT DISPLAY.



See Section 3.7.7, ○ Principle.

○ OPERATION



For the sake of clarity, when describing the Q-RPT DISPLAY, the Q-RPT displayed on the top line of the display when the Q-RPT function is selected is referred to as the “active” Q-RPT. The other Q-RPT to be displayed on the second (bottom) line of the RPM4-E-DWT display is referred to as the “inactive” Q-RPT. It is “inactive” in the sense that all Q-RPT specific functions and settings such as UNIT still apply to the “active” Q-RPT. To make changes to the “inactive” Q-RPT, for example to change its pressure measurement unit, it must be made the active Q-RPT by a range change (see Section 3.7.2).

To activate the Q-RPT DISPLAY, press [DISPLAY], <4RPT>. Operation returns to the MAIN RUN screen with the inactive Q-RPT displayed on the display's bottom line. The range of the inactive Q-RPT is always the default range, not an AutoRanged range (see Section 3.1.1).

With the Q-RPT DISPLAY active the main run screen is:

1. Active RPT display.
2. Inactive RPT display with Ready/Not Ready indicator on far left.

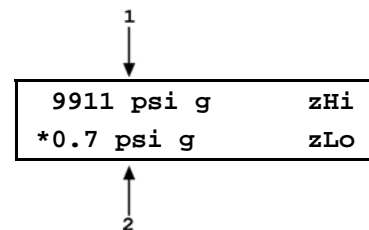

When the Q-RPT display is active, executing a range change to a range on the inactive Q-RPT makes the inactive Q-RPT the active Q-RPT. The DISPLAY defaults back to Rate (Section 3.7.2).

 To go to a DISPLAY other than Q-RPT , press [DISPLAY] and make a new DISPLAY choice (see Section 3.7.7).

3.7.7.5 Hi/Lo

○ PURPOSE

To activate the Hi/Lo DISPLAY.

 See Section 3.7.7, ○ Principle.

○ OPERATION

To activate the Hi/Lo DISPLAY press [DISPLAY], <5Hi/Lo>. Pressing <5Hi/Lo> resets the Hi/Lo values and returns to the main run screen with the Hi/Lo DISPLAY active.

With the Hi/Lo DISPLAY active the main run screen is:

1. Highest pressure observed since Hi/Lo reset.
2. Lowest pressure observed since Hi/Lo reset.

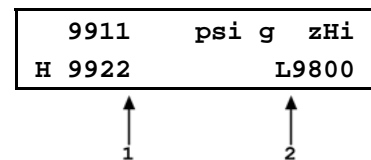

The Hi/Lo values change each time a new Hi or Lo pressure is measured.

 The Hi/Lo record can be reset at any time by pressing [ENT]. This allows a Hi/Lo reset without going back through the DISPLAY menu.

 If the pressure measurement unit, mode or range is changed while the Hi/Lo DISPLAY is active, Hi/Lo resets.

 To go to a DISPLAY other than Hi/Lo, press [DISPLAY] and make a new DISPLAY choice (see Section 3.7.7).

3.7.7.6 Freeze

○ PURPOSE

To activate the Freeze DISPLAY.

 See Section 3.7.7, ○ Principle.

○ OPERATION

To activate the Freeze DISPLAY press **[DISPLAY]**, **<6Freeze>**. Pressing **<6Freeze>** returns to the main run screen with the Freeze DISPLAY active.

With the Freeze DISPLAY active the main run screen is:

1. Pressure measured by active range of RPM4-E-DWT when [ENT] was pressed (displays 0.00 by default when Freeze DISPLAY is first activated).

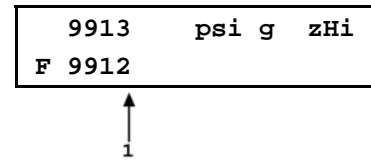

Pressing **[ENT]** causes the current pressure measured by the active RPM4-E-DWT Q-RPT to be captured and displayed.



If the pressure measurement unit, mode or range is changed while the Freeze DISPLAY is active, the Freeze value defaults back to zero.



To go to a DISPLAY other than Freeze, press **[DISPLAY]** and make a new DISPLAY choice (see Section 3.7.7).

3.7.7.7 Clean

○ PURPOSE

To activate the Clean DISPLAY.



See Section 3.7.7, ○ Principle..

○ OPERATION

To activate the Clean DISPLAY press **[DISPLAY]**, **<7Cln>**. Pressing **<7Cln>** returns to the main run screen with the Clean DISPLAY active.

With the Clean DISPLAY active the main run screen is:

1. Conventional main run screen first line.
2. "Clean" second line.

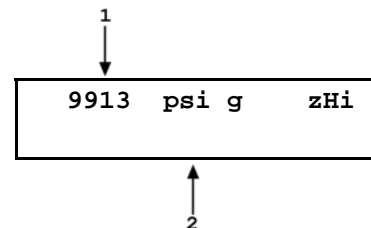

To go to a DISPLAY other than Clean, press **[DISPLAY]** and make a new DISPLAY choice (see Section 3.7.7).

3.7.8 [HEAD]

○ PURPOSE

To cause a pressure fluid head correction to be added to or subtracted from the pressure measured by the RPM4-E-DWT Q-RPT in order to predict the pressure at a height other than the E-DWT's reference level.

○ PRINCIPLE

The RPM4-E-DWT measures gauge pressure at the height of the E-DWT's top surface TEST port. Frequently, when performing a calibration or test, the device or system under test is at a different height than the E-DWT's TEST port. This difference in height, frequently called **head**, can cause a significant difference between the pressure measured by the E-DWT at its TEST port height and the pressure actually applied to the device under test at a different height. When that is the case, it is useful to make a head correction to the pressure measured by the RPM4-E-DWT in order to predict the pressure actually applied at a different height.

RPM4-E-DWT can accurately determine "head" pressures for liquids (oil, water) as the pressurized medium. In calculating the head value, standard gravity (9.80665 m/s^2) is used. A custom liquid density may also be specified.

The **[HEAD]** function key is used to specify the height difference between the E-DWT TEST port and another height. Entering a height of zero turns the function off. The height units and the test medium can be changed using **[SPECIAL]**, **<3Head>** (see Section 3.9.3).



An oil head has a pressure value of about 0.04 psi/inch (0.1 kPa/cm). As a general rule with RPM4-E-DWT A70M/A7M-AF, use of the HEAD function to assure in tolerance measurements is necessary only when the head exceeds 28 in. (70 cm) at 10 000 psi (70 MPa) or 0.28 in. (0.7 cm) at 100 psi, and proportional to these values in between.

○ OPERATION



For the head function to be used as described here, the RPM4-E-DWT must be AutoZeroed to the TEST port reference level following the AutoZeroing instructions in Section 3.7.10.

To access the HEAD function, press **[HEAD]**. The display is:

1. Test fluid currently specified for the head correction.
2. Edit field for head height.

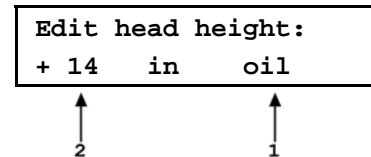

Edit the head height to the desired value. Press **[ENT]** to return to the MAIN RUN screen with the new head correction active. Press **[ESC]** to return with no changes.

For the head function to be used as described here, the RPM4-E-DWT must be AutoZeroed to the TEST port reference level following the AutoZeroing instructions in Section 3.7.10.

The reference height of the RPM4-E-DWT pressure measurement is the E-DWT TEST port weep hole. The head height should be entered as a positive value if the device or system under test is higher than the reference level and negative if it is lower.

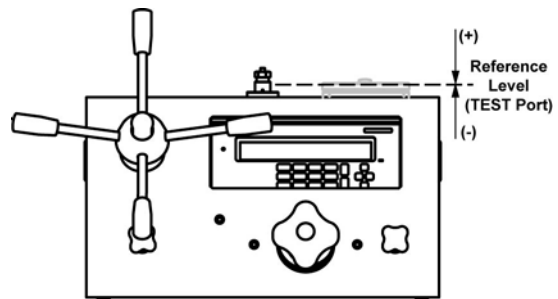



The HEAD function is NOT range specific. The HEAD ON or OFF status remains the same as Q-RPTs and ranges are changed. Edits made to the head settings are independent of active range or Q-RPT.



When a head correction is being applied, it is indicated by <h> in the fourth character from the right in the top line of the MAIN RUN screen (see Section 3.6.1). When the head correction is zero, the <h> is not shown.



The default head height unit is inches and the fluid oil. To change units of head height between inches and centimeters and to change the test fluid species, use [SPECIAL], <3head> (see Section 3.9.3).

3.7.9 [SDS]

○ PURPOSE

The SDS function is not used in RPM4-E-DWT A70M/A7M-AF.

3.7.10 [AutoZ]

○ PURPOSE

To run the AutoZ function that zeros the active Q-RPT.

○ PRINCIPLE

See Section 3.9.1, ○ Principle, for a full explanation of the AutoZ function.

The RPM4-E-DWT should be zeroed prior to running a calibration or test with the E-DWT.

○ OPERATION



For the AutoZ function key to run AutoZ, AutoZ must be turned ON for the active range and measurement mode. AutoZ ON is indicated by <z> to the left of the Q-RPT designator on the first line of the main run screen. AutoZ ON and OFF is set using [SPECIAL], <1AutoZ> (see Section 3.9.1). If AutoZ is OFF for the active Q-RPT, and measurement mode, <AutoZ is off> is displayed when [AutoZ] is pressed.

To properly zero the RPM4-E-DWT prior to running a calibration or test, proceed as follows:

- ❶ Close the reservoir shut off valve.
- ❷ Open the TEST shut off valve.
- ❸ Open the test system (disconnect) at the E-DWT TEST port.
- ❹ Be sure that the E-DWT is filled with oil up to the TEST port weep hole. Use the variable volume to raise the oil level if necessary.
- ❺ Press [AutoZ] from the RPM4-E-DWT main run screen. <Running gauge AutoZ> is displayed briefly before returning to the main run screen.



Before running AutoZ in gauge mode, ensure that the pressure applied to the Q-RPT is truly zero gauge (atmospheric pressure). If running AutoZ in gauge mode results in a zero offset that RPM4-E-DWT considers unusually large, <Confirm 0 gauge P!> is displayed. Check that zero gauge pressure is applied to the E-DWT TEST port, the reservoir shut off valve is closed and the TEST shut off valve is open.



Allow the RPM4-E-DWT to stabilize at atmospheric pressure for 2 to 3 minutes before running AutoZ in gauge mode.

3.7.11 [ENT] (RUN AUTOTEST)

○ PURPOSE

To run the AutoTest function which automatically runs a calibration test sequence (Quick Test or File Test).



Run AutoTest is accessed by pressing [ENT] from the Rate or Clean DISPLAY mode (see Section 3.7.7). In other DISPLAY modes, the function of [ENT] is specific to the mode.

○ PRINCIPLE

RPM4-E-DWT supports AutoTest automated sequences to assist in the testing or calibration of analog gauges and other pressure sensitive devices.

The AutoTest function is intended to:

- AutoRange the RPM4-E-DWT (see Section 3.7.5) to the range of the DUT being tested with settings appropriate for the tolerance of the DUT.
- Step the operator through a planned sequence of test pressure increments if desired.
- Alert the operator to possible out of tolerance conditions at each test point.
- Log test data in RPM4-E-DWT that can be viewed following the test.

There are two types of AutoTest: Quick AutoTest and File AutoTest.

- Quick AutoTest: The DUT and test parameters are entered “on the fly” during the initialization of the test, then the test is executed if desired. In Quick AutoTest tests, the test points are defined in % of test FS pressure.
- File AutoTest: The DUT and test parameters are stored in a file (see Section 3.8.5.2) and retrieved when a DUT is to be tested. In File AutoTests, test points are defined individually.

AutoTest operation is oriented towards running tests in which the pressure is set to the DUT cardinal point indication and then the actual reference pressure present is read from the RPM4-E-DWT.

AutoTest Settings and Calculations

The data required to initialize an AutoTest is either entered “on the fly” (Quick AutoTest) or retrieved from a file (File AutoTest). The data items required are:

- Pressure unit of measure.
- DUT full scale in pressure unit of measure.
- DUT tolerance in \pm % FS (full scale).

- Test increment in % FS (Quick AutoTest) or number of test increments and the value of each increment in the pressure unit of measure (File AutoTest).
- Test point sequence: ascending, descending or both (Quick AutoTest only).

The initialization data is used to AutoRange the RPM4-E-DWT appropriately for the DUT and test to be run. At the end of the AutoTest initialization, the RPM4-E-DWT is AutoRanged as follows (see Section 3.7.5, Table 4):

- RPT: The Lo Q-RPT is active if the maximum pressure in the AutoTest is equal to or less than 1 000 psi (7 MPa), the Hi Q-RPT is active if the maximum pressure in the AutoTest is greater than 1 000 psi (7 MPa).
- Pressure unit of measure: As specified in the AutoTest initialization.
- Display resolution: The DUT tolerance divided by 10 and rounded to the nearest digit, or 1 ppm of Q-RPT span, whichever is greater.
- Stability test for *Ready/Not Ready* indication (see Section 3.1.2): The DUT tolerance divided by 10, or 2 ppm of Q-RPT span, whichever is greater.
- Upper limit (UL): The DUT full scale plus 5 %, or the Q-RPT's maximum UL, whichever is less (see Section 3.8.4).

To AutoRange the RPM4-E-DWT based on DUT characteristics but not execute an AutoTest, the AutoTest can be aborted just after the initialization. Then the RPM4-E-DWT is set up appropriately for the DUT to be tested but the AutoTest increments don't execute.

See **OPERATION** in this Section for information on running a Quick or File AutoTest.

See Section 3.8.5.2 for information on setting up File AutoTest files.

See Section 3.8.5.1 for information on viewing the data files that result from running a File AutoTest.

O OPERATION

To run an AutoTest, press **[ENT]** from the Rate, RPT or Clean run screen (DISPLAY modes that do not use **[ENT]** (see Section 3.7.7)). The display is:

```
Run AutoTest:
1Quick 2File
```

Select **<1Quick>** to run a Quick AutoTest or **<2File>** to run a File AutoTest (see **PRINCIPLE** above in this Section) and operation proceeds to test initialization.

3.7.11.1 AUTOTEST INITIALIZATION

When **<2File>** is selected to run a File AutoTest, the test initialization information is obtained from the file selected. Operation proceeds directly to the test confirmation. The RPM4-E-DWT asks the operator to confirm the range of the AutoTest (**<ENTER to run...>**), AutoRanges (see Section 3.7.5) and operation proceeds directly to test execution (see Section 3.7.11.2).

When **<1Quick>** is selected to run a Quick AutoTest, the display is:

```
Run current Quick
AutoTest: 1yes 2no
```

Select **<1yes>** to rerun the last Quick AutoTest (see below in this Section). Select **<2no>** to define a new Quick AutoTest.

When **<2no>** is selected from the **<Run current Quick AutoTest>** screen, the AutoTest set-up/edit routine is accessed. The information needed to AutoRange RPM4-E-DWT based on the DUT characteristics is then collected in successive screens as follows.

- **<Pressure units of measure>**: The units of measure screen from the **[UNIT]** function key is presented (see Section 3.7.3). Select the desired pressure unit of measure. The choice of units may be modified (see Section 3.9.6).

- **<DUT full scale:>**: Enter the full scale pressure (maximum pressure) of the DUT in the measurement mode and pressure units that have been specified in the previous two steps.
- **<DUT tolerance:>**: Enter the DUT measurement uncertainty, accuracy or precision specification as desired in \pm % FS (percent of full scale). This value will be used to determine appropriate RPM4-E-DWT resolution and stability test settings.
- **<Test increment:>**: Enter the test increment in % FS of the DUT. When executing the test, the test increments will be from zero to the DUT full scale, dividing by the value of the increment. If a non-even increment value is entered, the actual increments will be rounded to the lower number of increments. For example, if the DUT full scale is 10 000 psi and the increment specified is 42 %, the Sequence will run points of 0, 5 000 and 10 000 psi because 42 % goes into 100 less than three but more than two times.
- **<Test point sequence:>**: Select <1up> for the AutoTest sequence to run from zero to the DUT full scale; <2down> for the sequence to start at the DUT full scale and run down to zero, <3u&d> for the sequence to run from zero to the DUT full scale and back to zero; <4d&u> for the sequence to run from the DUT full scale down to zero and back to the DUT full scale.

After the last test definition entry, a screen is offered for the user to check that the correct test has been defined or selected and that it does not exceed the range of the device or system being tested:

1. Indication of minimum and maximum pressure included in the sequence which is about to run.

```
ENTER to run psi g
0 to 5000
```



Pressing **[ESC]** returns to the AutoTest selection screen without AutoRanging the RPM4-E-DWT and without sequence execution. Pressing **[ENT]** causes the RPM4-E-DWT to AutoRange based upon the DUT characteristics (see Section 3.7.5) and the AutoTest proceeds to text execution (see Section 3.7.11.2). To AutoRange the RPM4-E-DWT based on DUT characteristics but not run a test sequence, **[ESC]** right after AutoRanging completes (at the **<Set valve for...>** screen).

3.7.11.2 TEST EXECUTION

The last step of test initialization is to AutoRange the RPM4-E-DWT (see Section 3.7.11.1), then test execution begins.

The first step of test execution is to set the E-DWT Lo Q-RPT shut off valve correctly for the Q-RPT that will be used to run the test (see 3.4). The RPM4-E-DWT display is (<XX> is Lo or Hi):

```
Set valve for XX RPT
```

Set the E-DWT shut off valve to shut off or connect the RPM4-E-DWT's Lo Q-RPT as indicated by the E-DWT valve indicator LED (see Section 3.4). Turn the valve knob fully towards the lit valve indicator LED until it reaches its stop. Press **[ENT]** when ready to proceed with the test.



To abort the test but use the RPM4-E-DWT with the settings for the DUT that was initialized, press **[ESCAPE]** from the **<SET VALVE FOR xx RPT>** screen. This can be useful for setting up the RPM4-E-DWT to make DUT adjustments or run tests other than the one defined by the AutoTest.

The display is:

```
0.0 psi g      Lo
Exercise DUT & [ENT]
```

The top line is the standard RPM4-E-DWT run screen indicating the current measured pressure (see Section 3.6.1). Exercise the DUT if desired using the top line indication of the measured pressure and press **[ENT]** when complete. The display is:

1. Standard RPM4-E-DWT run screen indicating current measured pressure.
2. Number of this test point/the total number of test points in the sequence.
3. Pressure to set for this increment in current pressure unit of measure and measurement mode.

```

1
↓
0.0 psi g      Lo
Set 0.0        1/11
↑             ↑
3             2

```

Adjust the pressure to the <Set nnnn> value indicated. Set the pressure so that the DUT, NOT the RPM4-E-DWT, indicates the <Set nnnn> value.

Once the specified pressure has been set, press **[ENT]**. If the RPM4-E-DWT pressure reading is in **Not Ready** condition (see Section 3.1.2), the RPM4-E-DWT makes an invalid entry sound and displays <Pressure NOT READY, TRY AGAIN>. Correct the conditions that are causing the RPM4-E-DWT reading to be excessively unstable and press **[ENT]** again. If the RPM4-E-DWT pressure reading is in **Ready** condition, the RPM4-E-DWT makes a valid entry sound and the display is:

1. Standard RPM4-E-DWT run screen indicating current measured pressure.
2. Number of this test point/the total number of test points in the sequence.
3. <F> to indicate freeze (see Section 3.7.7.7) followed by the RPM4-E-DWT pressure reading in current units of measure captured when **[ENT]** was pressed in the previous <Set> screen. This is the reference pressure that was applied to the DUT when the DUT indicated the cardinal point. The frozen pressure value flashes and <OT> follows the number if the reading was out of tolerance (definition of out of tolerance is: Set point – RPM4-E-DWT reading > DUT tolerance)..

```

1
↓
497.7 psi g    Lo
F497.6         OT  2/11
↑             ↑
3             2

```

Press **[ENT]** to accept this test point and proceed to the next test point or **[←]** to repeat the point.

Repeat the set pressure, take reading and accept data procedure until all points in the sequence have been accepted.

After the last pressure point in the sequence has been accepted the display is:

```
AutoTest complete
1data 2new 3repeat
```

Select <1data> to view the data collected in the AutoTest that was just completed (see Section 3.8.5.1).

Select <2new> to run a new Quick or File AutoTest.

Select <3repeat> to repeat the AutoTest that was just completed.

Press **[ESCAPE]** to return to the main run screen.

3.8 [SETUP]

○ PURPOSE

[SETUP] accesses a menu of functions and features commonly used in setting up and using the RPM4-E-DWT.

○ OPERATION

To access the SETUP menu, press [SETUP] from the MAIN RUN screen. The display is:

```
1range 2res 3stab
4UL 5ATest
```

SETUP menu choices include:

- <1range> Save and delete ranges created by AutoRange (see Section 3.8.1).
- <2res> Adjust the resolution of pressure displays (see Section 3.8.2).
- <3stab> Adjust the pressure stability limit that is the criterion for the *Ready/Not Ready* indication (see Section 3.8.3).
- <4UL> Adjust upper pressure limit alarm (see Section 3.8.4).
- <5ATest> Set up File AutoTest files and view data files resulting from running AutoTests (See Section 3.8.5).

3.8.1 <1RANGE>

○ PURPOSE

Save AutoRange ranges and associated settings for recall. Delete previously saved AutoRange ranges.

○ PRINCIPLE

The RPM4-E-DWT AutoRange function creates a range and automatically sets various operating parameters proportionally to the range (see Section 3.7.5). Operating settings can then be changed by the user. Many operating settings are specific to the current range (see Table 2).

[SETUP], <1range> allows the AutoRange range and associated settings to be saved for recall using the [RANGE] key (see Section 3.7.2). This can avoid having to recreate frequently used ranges and settings.

[SETUP], <1range> is also used to delete ranges that have been saved but are no longer needed.

3.8.1.1 SAVING AN AUTORANGE RANGE

○ OPERATION

To save a range created by AutoRange, the range must be the active range. Use AutoRange or AutoTest to create the range (see Sections 3.7.5, 3.7.11) and then make any desired feature and setting adjustments.

Once the AutoRange range is set up as desired, press [SETUP], <1range>, <1save>. The display is:

1. Indication that this is a range to be saved.
2. Designator and position of the Q-RPT used by the range to be saved.
3. Pressure unit of measure of the range to be saved.
4. Full scale pressure of the range to be saved.

```

      1           2
      ↓           ↓
Save range A70M Hi
psi 5000g
      ↑           ↑
      3           4

```

Press **[ENT]** to save the range or **[ESC]** to return to the MAIN RUN screen without saving the range.



Default (<DF>) Q-RPT ranges cannot be saved. They are permanent.

Duplicate AutoRange ranges cannot be saved. A duplicate AutoRange range is a range that has the same measurement mode and full scale and uses the same Q-RPT as a range that has already been saved.

3.8.1.2 DELETING AUTORANGE RANGES

○ OPERATION

To delete a single saved AutoRange range, press **[SETUP]**, **<1range>**, **<2delete>**. If there are any saved ranges available to delete, the display is:

1. Indication that the cursor control keys may be used to toggle through the saved ranges to select the one to be deleted.
2. Designator and position of the Q-RPT used by the range to be deleted.
3. Pressure unit of measure of the range to be deleted.
4. Full scale pressure of the range to be deleted.

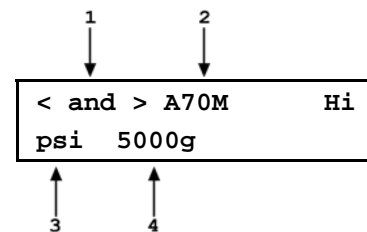

Use the cursor control keys to toggle through the ranges available to be deleted. When the desired range to be deleted is displayed, press **[ENT]**. If you are sure you want to delete this range, press **[ENT]** again in response to the **<Delete?>** query. **[ESC]** returns to the **<AutoRange:>** screen without deleting a range.

To delete all of the saved AutoRange ranges, press **[SETUP]**, **<1range>**, **<3delete all>**. If you are sure you want to delete all the ranges, respond **<1yes>** to the **<Delete all saved ranges?>** query. If not, respond **<2no>**.

3.8.2 <2RES> (RESOLUTION)

○ PURPOSE

To set the resolution with which measured pressures and other pressure indications and settings are displayed.

○ PRINCIPLE

The resolution with which RPM4-E-DWT displays pressure values can be adjusted.

The resolution setting determines the number of digits with which pressure is displayed. The resolution is calculated based on the span of the range and then rounded to the furthest digit to the right. For example, resolution of 0.001 % on a range of 1 500 psi is $1\ 500 \times 0.001\ \% = 0.015$ which is rounded down to 0.01 psi.



Default resolution is 0.01% of active range span. Resolution is set automatically by AutoRange (see Section 3.7.5) and by AutoTest initialization (see Section 3.7.11).

○ OPERATION

To access the resolution function, press **[SETUP]**, **<2res>**. The display is:

```
Display resltn: Hi
0.0100 %FS < and >
```

Use the cursor control keys to set the desired level of resolution. Press **[ENT]** to return to the MAIN RUN screen with the new resolution setting active or **[ESC]** to make no changes.



The resolution setting is range specific. A resolution setting made in one range does NOT affect other ranges.



The maximum resolution setting is limited in AutoRange ranges that are less than 10% of the Q-RPT default full scale.

3.8.3 <3STAB> (STABILITY)

○ PURPOSE

To view and/or adjust the stability test that is the Ready/Not Ready criterion for the active Q-RPT and range.



See Section 3.1.2 Pressure Ready/Not Ready.

○ PRINCIPLE

The RPM4-E-DWT continuously monitors the rate of change of pressure measured by the active Q-RPT and compares this rate to the active stability limit to make a *Ready/Not Ready* determination (see Section 3.1.2). The stability function allows the stability limit to be adjusted by the user to increase or decrease the stability required for a *Ready* condition to occur.



Default stability when using AutoRange is $\pm 0.01\%$ FS of active range span. Default stability when AutoRanging as part of an AutoTest is 10% of the DUT tolerance (see Section 3.7.5, Table 4).



The stability limit is separate and different from the Rate DISPLAY function (see Section 3.7.7.2) which allows the current rate of change of pressure to be displayed.

○ OPERATION

To access the stability setting adjustment, press **[SETUP]**, **<3stab>**. The display is:

Stability limit: Hi 1.0 psi/s

Edit the desired stability limit setting. **[ENT]** activates the stability limit for the active range and returns to the main run screen. Press **[ESC]** to return to the MAIN RUN screen with no change to the stability limit.



The stability setting is range specific. A stability setting made in one range does NOT affect other ranges.

3.8.4 <4UL> (UPPER LIMIT)

○ PURPOSE

To set the upper pressure limit value for a pressure range and measurement mode.

○ PRINCIPLE

The UPPER LIMIT function provides the user with a settable pressure limit at which an alarm sounds.

When the limit is reached, RPM4-E-DWT's beeper sounds intermittently as long as pressure is above the limit.

The UPPER LIMIT function has two purposes. First, when UL is set to its default value, it serves as a warning that the maximum pressure of the active range is about to be exceeded. Second, UL can be set by the user to a value other than the default value to provide an alarm that a specific pressure limit has been exceeded. This feature is often used to help protect a system to which RPM4-E-DWT is connected. For example, it might be set just over the full scale of a device under test (DUT) that is being calibrated. Note that using AutoRange or AutoTest automatically sets the UL to just above the AutoRange full scale (see Sections 3.7.5, 3.7.11).



The default upper limit is 105 % of AutoRange span or 102 % of Q-RPT default (maximum) range when AutoTest is used, whichever is lower.

○ OPERATION

To view or edit upper limit of the active range press **[SETUP]**, **<4UL>**.

The display is:

1. Entry field for upper limit value in active pressure unit of measure and measurement mode.

Upper limit:	Hi
10200 psi g	



Edit the upper limit value as desired. The maximum upper limit is 105 % of span in an AutoRange range or 102 % of default Q-RPT full scale, whichever is smaller. Press **[ENT]** to return to the MAIN RUN screen with the new upper limit active. Press **[ESC]** to return to the MAIN RUN screen with no change to the upper limit.

When the upper limit has been exceeded, the display of current pressure flashes and a beep sounds for 3 seconds on/2 seconds off intervals. Reduce the pressure applied to RPM4-E-DWT so that it is below the upper limit to return to normal operation.



Upper limit values are specific to each range and measurement mode.

3.8.4.1 OVER PRESSURE FUNCTION

In addition to the UL function, RPM4-E-DWT has an over pressure function.

The over pressure function executes when a Q-RPT measures a pressure that is greater than 110% of the Q-RPT's default span. This is 1100 psi (7.56 MPa) for the A7M Q-RPT and 11000 psi (75.6 MPa) for the A70M Q-RPT.

The over pressure function causes the measured pressure display to flash. The overpressure function also logs the time and date of the overpressure condition in both user and factory logs to assist in incident diagnosis (see Section 3.9.7.5).

To recover from an overpressure condition, cycle RPM4-E-DWT power. Before cycling power, be sure to correct the condition that caused the overpressure.

3.8.5 <5ATEST>

○ PURPOSE

To view data collected while running an AutoTest and/or to view and edit File AutoTest definition files.

See Section 3.1.3, **PRINCIPLE** for information on the AutoTest function.

○ OPERATION

To access the ATest menu select **[SETUP], <5ATest>**. The display is:

Select **<1data>** to view AutoTest results data (see Section 3.8.5.1).

AutoTest: 1data 2file

Select **<2file>** to view or edit an AutoTest definition file (see Section 3.8.5.2).

3.8.5.1 DATA

○ PURPOSE

To view the data files that are created when an AutoTest is run.

○ PRINCIPLE

RPM4-E-DWT supports AutoTest automated tests (see Section 3.1.3). When an AutoTest is run, the RPM4-E-DWT pressure measurement accepted by the operator at each point is logged. The logged pressure measurements and an identifying header are stored in a data file. The data file can be viewed immediately following the last point of the sequence by selecting **<1data>**. In addition, the last ten data files recorded can be viewed anytime by selecting **[SETUP], <5ATest>, <1data>**.

Data File Protocol

Up to ten data files are buffered, ten at a time, in RPM4-E-DWT memory. When a new AutoTest run is completed, its data file goes to the back of the queue and the oldest data file is deleted.

Data files are identified by a header whose first line is the full scale of the DUT and the number of test points in the AutoTest. The second line is the date (YYYYMMDD) and time (HH:MMa) at which the last point of the sequence was accepted.

Following the data file header, each test point is recorded including the pressure reading of the RPM4-E-DWT with head, AutoZ and range status as well as an indication of whether the reading was out of tolerance and the test point number over the total number of test points in the Sequence.

○ OPERATION

To access the AutoTest results data file viewing function press **[SETUP], <5ATest>, <1data>**.

The first display is the data file header which can be used to toggle through data files:

1. Full scale of the AutoTest with pressure unit of measure and measurement mode.
2. Number of test points executed/total number of points in the AutoTest.
3. Date and time that the last point in the AutoTest was executed.

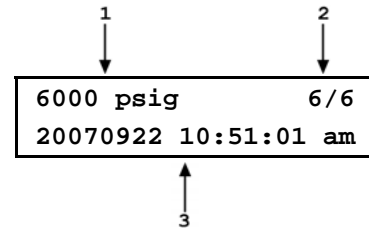

Press **[+/-]** or **[→]** to scroll through the headers of the other AutoTest data files available. RPM4-E-DWT stores up to ten AutoTest data files in order of execution with a new data file pushing all the files back and deleting the oldest one. When the header of the AutoTest data file you would like to view appears, press **[ENT]** to view the first point of the identified AutoTest data file.

The display is:

1. RPM4-E-DWT reading logged for the test point.
2. Head, AutoZ and Q-RPT indicator (same as in the RPM4-E-DWT main run screen) (see Section 3.6.1).
3. Indication that this is an AutoTest data file view screen.
4. **<FA>** indicating that the AutoTest was a File AutoTest or **<QA>** indicating a Quick AutoTest. This is preceded by **<OT>** if the test point was out of tolerance (definition of out of tolerance is Set point – RPM4-E-DWT reading > DUT tolerance).
5. Number of this test point over total number of points in the AutoTest.

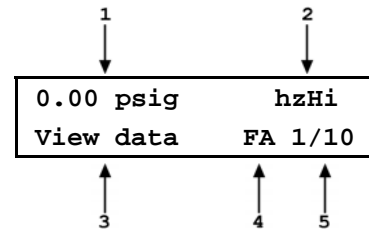

Press **[ENT]** to move to the next data point. Press **[←]** or **[→]** to scroll backward and forward through the test points. The data file header is between the first point and the last point.

Press **[ESC]** to exit the data file. Confirmation is required to exit the data view function.



Up to ten data files are buffered, ten at a time, in RPM4-E-DWT memory. When a new AutoTest run is completed, its data file goes to front of the queue and the oldest data file is deleted.

3.8.5.2 FILE

○ PURPOSE

To view and edit File AutoTest definition files.

○ PRINCIPLE

RPM4-E-DWT supports AutoTests (see Section 3.7.11, ○ PRINCIPLE). There are two types of AutoTests:

- Quick AutoTests in which the DUT and test parameters are entered “on the fly” during the initialization of the test.
- File AutoTests in which the DUT and test parameters are stored in a file and retrieved when the file is selected to run an AutoTest.

File AutoTest parameters are stored in definition files. **[SETUP], <5AutoTest>, <2file>** allows File AutoTest definition files to be viewed and edited. Up to 40 File AutoTest definition files with up to 21 test points in each file can be created.

A File AutoTest definition file defines:

- The identifying number of the File AutoTest definition file.
- Pressure unit of measure.
- DUT full scale in pressure unit of measure and measurement mode.
- DUT tolerance (% FS).
- Number of test points or pressure targets to include in the AutoTest.
- Numerical value of each test point or pressure target.

See Section 3.7.11, **○ OPERATION** for information on running a Quick or File AutoTest.

See Section 3.8.5.1 for information on viewing the data files that result from running a Sequence.

○ OPERATION



See Section 3.7.11, **OPERATION**, for information on **RUNNING** a Quick or File AutoTest.

To access the AutoTest definition viewing and editing functions press **[SETUP], <5ATest>, <2file>**. Select **<1view>** to view an AutoTest definition file. Select **<2edit>** to edit an AutoTest definition file.

When **<2edit>** is selected the display is:

```

Edit File AutoTest #
1

```

Enter the number (1 - 40) of the File AutoTest to be edited.



To create a File AutoTest definition file similar to an existing definition file without entering all the definition information, edit an existing definition file and at the end of the editing process, save it as a different file number.

The display is:

```

1psi 2MPa 3kPa
4bar

```

The unit of measure selection screen is the current **[UNIT]** selection screen (see Section 3.7.3). Select the desired pressure measurement unit for the AutoTest.

The display is:

```

DUT full scale:
6000 psi g      File1

```

Enter the full scale pressure of the DUT to be calibrated with this File AutoTest. The value entered will be used along with the DUT tolerance to AutoRange RPM4-E-DWT settings when the File AutoTest is run (see Section 3.7.5, **○ PRINCIPLE**).

The display is:

```

DUT tolerance:
0.25% FS      File1

```

Enter the tolerance in % of full scale (measurement uncertainty, precision or accuracy as desired) of the DUT to be calibrated using this File AutoTest. The value entered will be used along with the DUT full scale to determine

RPM4-E-DWT AutoRange settings when the AutoTest is run (see Section 3.7.11, **O PRINCIPLE**).

The display is:

```
Number of targets:
1                File1
```

Enter the total number of pressure points or target pressures to be included in the AutoTest. The maximum number of points is 21. If data is to be taken at “zero” pressure, include the “zero” points in the point count.

The display is:

```
Pressure target N:
0.0 psi g        File1
```

Enter the numerical value of the target pressure point <N>. Repeat until all of the points in the File AutoTest have been defined.

The display is:

```
Pressure target N:
0.00 psi g       File1
```

Enter the identifying number under which this File AutoTest definition file is to be saved. A confirmation is required to overwrite an existing sequence.

While editing a File AutoTest, pressing **[ESC]** backs through entries until editing of the pressure target values has begun. Then **[ESC]** can only be used to abandon editing.

3.9 [SPECIAL]

O PURPOSE

[SPECIAL] accesses a menu of RPM4-E-DWT functions and features that are less commonly used or not normally used in regular operation.

O OPERATION

Press **[SPECIAL]** from the MAIN RUN screen to access the SPECIAL menu. The display is:

```
1AutoZ 2remote 3head
4SDS 5prefs 6Punit
7intern 8cal 9reset
```



Some screens, such as the SPECIAL menu, go beyond the two lines provided by the display. This is indicated by a flashing arrow in the second line of the display. Press the cursor control keys to move the cursor to access the lines that are not visible or directly enter the number of the hidden menu choice if you know it.

SPECIAL menu choices include:

- <1AutoZ>** Manage the AutoZero function for the active Q-RPT (see Section 3.9.1).
- <2remote>** View and edit COM port (RS-232) and IEEE-488 interface settings. Select remote syntax style (see Section 3.9.2).
- <3head>** Set HEAD function fluid and height unit of measure (see Section 3.9.3).
- <4SDS>** Feature not used in the RPM4-E-DWT A70M/A7M-AF model.
- <5prefs>** View and set screen saver time, keypad sound frequency, unit ID number, time/date, security protection level (see Section 3.9.5).
- <6Punit>** Customize the **[UNIT]** key pressure unit of measure selections (See section 3.9.6).
- <7intern>** View internal barometer, view and set pressure reading rate setting, view incident log (see Section 3.9.7).
- <8cal>** View and adjust RPM4-E-DWT Q-RPT and barometer calibration coefficients (see Sections 3.9.8, 5.2.2).
- <9reset>** Access RPM4-E-DWT's various reset functions (see Section 3.9.9).

3.9.1 <1AutoZ>

○ PURPOSE

To turn ON and OFF the AutoZ function that allows the Q-RPT reading to be zeroed and the dynamic compensation for atmospheric pressure changes feature. Also, view and adjust the value of the AutoZ offset.



To RUN the AutoZ routine that zeroes the Q-RPT, use [AutoZ] (see Section 3.7.10).

○ PRINCIPLE

AutoZ Purpose and Principle

The RPM4-E-DWT AutoZero function (AutoZ) is used to achieve gauge measurement mode with the RPM4-E-DWT's intrinsically absolute Q-RPTs and to eliminate the influence of zero drift on measurement uncertainty. AutoZ can also tare out fluid heads between the E-DWT and the device under test.

The AutoZ functions provides full on-board support for regular zeroing including determination, application and storage of offset values as well as dynamic compensation for changes in atmospheric pressure between zeroing opportunities. The operator initiates Q-RPT zeroing by pressing the **[AutoZ]** key from the main run screen when zero (atmospheric pressure) is applied to the RPM4-E-DWT Q-RPT.

The AutoZero function uses four values:

1. $P_{std,0}$: Zero (atmospheric pressure) which is supplied by definition when the Q-RPT is active, the reservoir shut off valve is close, the TEST shut off valve is open and the TEST port is disconnected and filled with oil to the weep hole (reference level).
2. $P_{u,0}$: The absolute pressure reading of the Q-RPT, with no AutoZ offset, at the time **[AutoZ]** is pressed.
3. $P_{offset,G}$: The difference between the reading of the Q-RPT with no AutoZ offset when **[AutoZ]** is pressed ($P_{u,0}$), and zero gauge pressure (atmospheric gauge pressure) ($P_{std,0}$):

$$P_{offset,G} = P_{u,0} - P_{std,0}$$

4. ΔP_{atm} : The difference between atmospheric pressure (absolute) as measured by the RPM4-E-DWT's on-board barometer when **[AutoZ]** was last pressed and the current measured value. ΔP_{atm} is used to compensate real time for the evolution of atmospheric pressure between updates of $P_{offset,G}$ by **[AutoZ]**. ΔP_{atm} is dependent only upon the ability of the barometer to measure small changes in atmospheric pressure over short time periods, not upon the barometer's absolute accuracy or long term stability.

The gauge pressure measured by the RPM4-E-DWT Q-RPT at any given moment is:

$$P_{gauge} = P_u - P_{offset,G} - \Delta P_{atm}$$

The AutoZ function can be turned ON and OFF. When the AutoZ function is OFF, the **[AutoZ]** function to rezero the RPT is no longer available and dynamic compensation for changes in atmospheric pressure using the RPM4-E-DWT's on-board barometer is no longer active. AutoZ should be left on at all times unless the RPM4-E-DWT's on-board barometer is inoperable.

○ OPERATION



The AutoZ function and values are Q-RPT specific.



To RUN the AutoZ routine that rezeroes the Q-RPT, use [AutoZ] (see Section 3.7.10).

To access the RPM4-E-DWT AutoZ function press **[SPECIAL]**, **<1AutoZ>**. The display is:

1. Active Q-RPT designator.
2. Indication of active measurement mode (always **<gauge>** for gauge in the RPM4-E-DWT A70M/A7M-AF model).
3. Indication of whether AutoZ is currently ON or OFF for this Q-RPT.

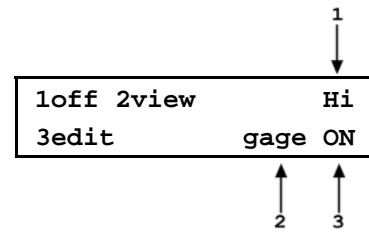

Select **<1off>** (or **<1on>**) to change the AutoZ status for the current Q-RPT and measurement mode from ON to OFF or vice versa.

 *AutoZ ON is indicated by a <z> in the MAIN RUN screen, top line, third character from the right. When AutoZ is OFF, the character is blank. AutoZ should always be left ON in RPM4-E-DWT A70M/A7M-AF unless the on-board barometer becomes inoperable.*

Select **<2view>** to view the current value of P_{offset} for the active Q-RPT.

 *The value of P_{offset} is always displayed and entered in Pascal (Pa). P_{offset} should be roughly equal to atmospheric pressure.*

Select **<3edit>** to edit the value of P_{offset} for the active Q-RPT and measurement mode.

Edit P_{offset} as desired and press **[ENT]** to activate the new value. Press **[ESC]** to abandon changes.

 *There is no reason to edit P_{offset} during normal RPM4-E-DWT operation or maintenance. P_{offset} should only be adjusted using [AutoZ] (see Section 3.7.10).*

3.9.2 <2REMOTE>

○ PURPOSE

To configure the RPM4-E-DWT COM1 and COM2 communication ports. To test COM1 and COM2 communications. To select the remote programming communications format.

○ PRINCIPLE

The RPM4-E-DWT has two RS-232 communications ports referred to as COM1 and COM2. COM1 is for communicating with a host computer (see Section 4), and COM2 is reserved for communicating with an external device (e.g. an RPM4-E-DWTx, a multimeter, etc.). The ports' settings can be viewed and changed using **[SPECIAL]**, **<2remote>**.

RPM4-E-DWT has two remote communications formats, classic and enhanced (see Section 4.3). The active format can be selected.

A self test is supplied for RS-232 communications. The self test allows verification that the RPM4-E-DWT RS232 ports (COM1 and COM2) are operating properly and that a valid interface cable is being used.

○ OPERATION

To access the communications settings, press **[SPECIAL]**, **<2Remote>**.

- Select **<1COM1>** to view and edit COM1 settings (see Section 3.9.2.1).
- Select **<2COM2>** to view and edit COM2 settings (see Section 3.9.2.1).

- Select **<4format>** to select the remote communications command format (see Section 3.9.2.3).
- Select **<5RS232test>** to run the COM1 and COM2 communications test (see Section 3.9.2.4).

3.9.2.1 <1COM1, 2COM2>

The COMx ports can be set for specific communications settings. The settings are baud rate, parity, data bits and stop bits. The available options are:

Baud 300, 600, 1 200, 2 400, 4 800, 9 600, 19 200, 28 800, 38 400

Parity NONE, ODD or EVEN

Length 7 or 8

Stop Bit 1 or 2

The default is <2 400, E, 7,1> for both COM1 and COM2.

The user can also specify one or two termination characters, referred to as “Term1” and “Term2”, as well as define these characters. These define the characters that mark the end of commands that are sent to the RPM4-E-DWT as well as mark the end of replies sent back to the host computer. The RPM4-E-DWT typically uses the **<Term1>** character to mark the end, and will ignore the **<Term2>** character. The characters can be any decimal number from 1 to 255. The defaults are **<13>** (carriage return) and **<10>** (line feed) and usually should not be changed.

3.9.2.2 <3IEEE-488>

An IEEE-488 interface is not included in the E-DWT A70M/A7M-AF model.

3.9.2.3 <4FORMAT>

The RPM4-E-DWT has two different syntax formats available for the remote program commands.

The **classic** remote command format is highly intuitive and conforms with previous **DHI** PPC and RPM4 products.

The **enhanced** remote command format generally uses the same commands as the **classic** format, but in addition it follows the syntax, format, and status reporting features of IEEE Std 488.2.

The details of each format are covered in Section 4.3.

[SPECIAL], **<2remote>**, **<4format>** allows the remote program command syntax to be selected. The cursor is on the active format. Select **<1classic>** or **<2enhanced>** as desired.

3.9.2.4 <5RS232 SELF-TEST>

The RS232 self-test is provided to check the RPM4-E-DWT COM ports and the interface cable independently of an external device or computer.

If you are having difficulty communicating with RPM4-E-DWT from a host computer using RS232, the RS232 self test can help establish that the RPM4-E-DWT COM1 port you are trying to communicate with and the interface cable you are using are good.

To run a self test of the RS232 ports (COM1 and COM2), press **[SPECIAL]**, **<2remote>**, **<5RS232test>**.

The display prompts you to connect COM1 to COM2 using a standard pin-to-pin DB-9F to DB-9M RS232 cable.

Once the cable has been installed, press [ENT] to run the self-test. The test is first executed in the COM1→COM2 direction and then in the COM2→COM1 direction.

If the COM1→COM2 test passes: <PASSED> displays briefly and the test proceeds to COM2→COM1.

If COM2→COM1 passes: <PASSED> is displayed briefly followed by the conclusion, <The RS232 test has PASSED>.

If a test fails: Execution is suspended until [ENT] is pressed.



The RPM4-E-DWT RS232 test can fail for three reasons:

The RS232 cable being used is incorrect (Section 4.2.1.1, 4.2.1.2) for information on the correct cable).

COM1 and COM2 do NOT have the same serial communications settings and therefore cannot communicate together (see Section 3.9.2.1 to set the COM ports).

COM1 or COM2 is defective.

The reason for failed communications is almost always a cable or incorrect RS232 interface settings. Be sure that these are correct before concluding that a COM port is defective.

3.9.3 <3HEAD>

○ PURPOSE

To view or change the properties of the HEAD function (see Section 3.7.8) including the unit of measure of length for head height entry and the test fluid type and species for density calculations.

○ OPERATION

From the MAIN RUN screen, press [SPECIAL], <3Head>.

Select the desired height unit of measure and press [ENT].

Select <1gas> or <2liquid> depending on the pressurized medium between the RPM4-E-DWT and the height at which pressure is to be calculated. Select the gas or liquid species. The liquid selection <3User>, is to create a custom liquid with a user entered density.

Use [HEAD] to set a head height if desired.

3.9.4 <4SDS>

○ PURPOSE

This feature is not used in RPM4-E-DWT A70M/A7M-AF.

3.9.5 <5PREFS>

○ PURPOSE

To access a menu of RPM4-E-DWT operational preferences and functions.

○ OPERATION

To access the PREFS menu press **[SPECIAL]**, **<5prefs>**. The display is:

1ScrSvr 2sound 3time
4ID 5level

The PREFS menu includes:

- <1ScrSvr>** View and change the screen saver activation time (see Section 3.9.5.1).
- <2sound>** View and change the key press sounds (see Section 3.9.5.2).
- <3time>** View and edit the internal time and date settings (see Section 3.9.5.3).
- <4ID>** View the RPM4-E-DWT serial number (SN) and view or edit the ID number (see Section 3.9.5.4).
- <4level>** View and set the user security level and/or password (see Section 3.9.5.5).

3.9.5.1 <1SCRSVR>

○ PURPOSE

To adjust the idle time after which RPM4-E-DWT's SCREEN SAVER activates.

○ PRINCIPLE

RPM4-E-DWT has a SCREEN SAVER function which causes the display to dim after a front panel key is NOT pressed for a certain amount of time. The default is for the screen saver to activate after 10 idle minutes. The screen saver activation time can be adjusted by the user or screen saving can be completely eliminated.



Setting screen saver time to zero eliminates the SCREEN SAVER function so that the display permanently remains at full brightness.

○ OPERATION

To access the SCREEN SAVER function, press **[SPECIAL]**, **<5prefs>**, **<1ScrSav>**. Edit, in minutes, the idle time after which screen saver will activate to dim the screen. Set the time to zero to eliminate the SCREEN SAVER function.

3.9.5.2 <2SOUND>

○ PURPOSE

To adjust or suppress the RPM4-E-DWT valid key press sound.



See Section 3.6.4 for information on the complete list of sounds made by RPM4-E-DWT and their meanings.

○ PRINCIPLE

RPM4-E-DWT provides audible feedback by a brief “beep” when a valid key press is made. The tone frequency of this beep may be selected from three choices or it may be completely suppressed. Invalid key presses are indicated by a descending two tone “blurp” which cannot be suppressed.

○ OPERATION

To access the keypad sound adjustment function press **[SPECIAL]**, **<5prefs>**, **<2sound>**.

Select between **<2lo>**, **<3mid>** or **<4hi>** to adjust the valid key press tone frequency.

Select **<1none>** to suppress the valid key press tone.



The sound function only affects the valid key press tone. The invalid key press tone and other RPM4-E-DWT sounds cannot be adjusted or suppressed.

3.9.5.3 <3TIME>

○ PURPOSE

To view and edit the RPM4-E-DWT internal time and date settings.

○ OPERATION

To access the TIME function press **[SPECIAL]**, **<5prefs>**, **<3time>**.

The display is:

Edit: 1time 2date 08:32:11 am 20080125

Select **<1time>** to edit the time. Edit hours, then minutes, then am/pm by pressing **[ENT]** after each entry. Seconds go to zero when minutes are entered. This can be used to synchronize the time with a time standard.

Select **<2date>** to edit the date. The date must be specified in YYYYMMDD format.



The RPM4-E-DWT date and time are set to United States Mountain Standard Time in the final test and inspection process at the factory. If desired, use the TIME and DATE function to set your local time and date.

3.9.5.4 <4ID>

○ PURPOSE

To view or edit the RPM4-E-DWT user ID and to view the RPM4-E-DWT serial number.

○ OPERATION

To access the ID function press **[SPECIAL]**, **<5prefs>**, **<4ID>**.

Select **<1view>** to view the current ID.

Select **<2edit>** to edit the ID.

The ID has twelve characters. When the edit screen is opened, the cursor is on the first character. Numerical values can be entered directly from the keypad. In addition, the cursor control keys can be used to toggle through a list of available alphanumeric characters. Holding the key slews through the characters. Character order going up is: blank space, symbols, lower case letters, upper case letters, and numbers. After selecting a character, press **[ENT]** to activate it and move to the next character field.

When a character is selected the cursor moves to the next character. To leave a blank character, press **[ENT]** with the field for that character blank. Use this for the trailing characters if the ID being entered is less than twelve characters.

After the last of the twelve characters has been entered, the **<Save ID?>** option is offered. Select **<1no>** to return to the ID edit screen. Select **<2yes>** to save the edited ID.



The ID can be set remotely from a computer which is quite a bit more convenient than entering characters from the keyboard (see Section 4.4.4, “ID” command). The ID is not cleared or reset by any RESET function (see Section 3.9.9).

3.9.5.5 <5LEVEL> (SECURITY)

○ PURPOSE

To set user protection levels to restrict access to certain functions and to edit the password required for changing user levels.

○ PRINCIPLE

RPM4-E-DWT’s front panel user interface provides the means to access all RPM4-E-DWT user defined data, settings and functions including calibration data. Inadvertent, uninformed or unauthorized altering or deleting of data, settings and functions could require extensive reconfiguration by the user and might cause invalid readings and behavior. For these reasons, depending upon the application in which RPM4-E-DWT is being used, it may be desirable to restrict access to some functions. The user level function provides a means of restricting access to certain functions. Four different levels of security are available.

Access to changing security levels can be left open, or be protected by a password.

Security Levels

The security levels are structured to support typical operating environments as follows:

- None** This level is intended for use only by the system manager and/or calibration facility. It allows access and editing in all areas including critical metrological information.
- Low** Low security is designed to protect the specific metrological information and SYSTEM DIAGNOSTIC AND MAINTENANCE functions of the system against accidental alteration. It is intended for an advanced operator performing many different tasks. Low security is the default user level setting.
- Medium** Medium security is designed to protect specific metrological information in the system and to assure that the RPM4-E-DWT is operated using consistent operational parameters.
- High** High security is designed to protect all operating parameters. It is intended to minimize operator choices, for example to perform repeated identical calibrations under consistent conditions.



RPM4-E-DWT is delivered with the security level set at low to avoid inadvertent altering of critical internal settings but with access to changing security levels unrestricted. It is recommended that the low security level be maintained at all times. If there is a risk of unauthorized changing of the security level, changing authority should be password protected (see ○ OPERATION of this section).

The security levels are structured to support typical levels of operation as shown in Table 5. Specifically, the security levels prevent execution of the functions accessed by the key strokes marked by “•”:

Table 5. Security levels

FUNCTION	LOW	MEDIUM	HIGH
[RANGE]			•
[ENT] (AutoTest)			•
[UNIT]			•
[MODE]			•
[AutoRange]		•	•
[LEAK CK]			•
[DISPLAY]		•	•
[HEAD]			•
[SDS] (NOT USED IN THIS RPM4-E-DWT MODEL)			
[AutoZ] (in absolute mode)		•	•
[SETUP]			•
[SETUP], <1range>		•	•
[SETUP], <2res>		•	•
[SETUP], <4UL>		•	•
[SETUP], <5ATest>		•	•
[SPECIAL]			•
[SPECIAL], <1AutoZ>		•	•
[SPECIAL], <1AutoZ>, <1on/1off>	•	•	•
[SPECIAL], <1AutoZ>, <3edit>	•	•	•
[SPECIAL], <2remote>			•
[SPECIAL], <2remote>, make changes		•	•
[SPECIAL], <3head>		•	•
[SPECIAL], <4SDS> (NOT USED IN THIS RPM4-E-DWT MODEL)		•	•
[SPECIAL], <5pref>, <1ScrSvr>		•	•
[SPECIAL], <5pref>, <2sound>		•	•
[SPECIAL], <5pref>, <3time>		•	•
[SPECIAL], <5pref>, <3time>, make changes	•	•	•
[SPECIAL], <5pref>, <4ID>, <2edit>	•	•	•
[SPECIAL], <6Punit>		•	•
[SPECIAL], <7intern>		•	•
[SPECIAL], <7intern>, <3RPT2x> (NOT USED))	•	•	•
[SPECIAL], <7intern>, <5log>, clear log	•	•	•
[SPECIAL], <8cal>		•	•
[SPECIAL], <8cal>, <2edit> under any selection	•	•	•
[SPECIAL], <4reset>		•	•
[SPECIAL], <4reset>, <4cal>	•	•	•
[SPECIAL], <4reset>, <5all>	•	•	•
Remote communications disabled			•

“•” indicates the function/menu is NOT accessible.

○ OPERATION

RPM4-E-DWT is delivered with no active password and access to the User Level menu is open. The user level is set to **<1Low>**. User levels can be changed freely until a password has been created.

To access the LEVEL function press **[SPECIAL], <5prefs>, <5level>**. The display is:

```
1change user level
2edit password
```

Selecting **<1change user level>** brings up the restriction menu:

```
Restrictions: 1none
2low 3medium 4high
```

The cursor is on the current restriction level. Select a different level or or **[ESC]** back to the MAIN RUN screen.

If no password is active, selecting **<2edit password>** displays the user password and allows it to be edited.

```

Password: pppppp
0 disables password
    
```

 Once a password has been entered, the user level cannot be changed without reentering the password.

Passwords can be up to six numbers in length and cannot start with a zero. If **<0>** is entered, the password is made inactive and the user will not be required to enter a password to access the user level menu. This condition, with a security level of **<2low>**, is the factory default.

If there is an active password, the RPM4-E-DWT password entry screen appears. The user must enter the user defined password or the factory secondary password to proceed further:

```

RPM4-E-DWT SNnnnn-
xx
Password: pppppp
    
```

The first field, **<nnnn>**, is the serial number of the RPM4-E-DWT, followed by a second field, **<xx>**, that represents the number of times that a secondary password has been used. The second field, **<xx>**, increments each time a secondary password is used. The third field, **<pppppp>** is for user entry of the normal password.

 The factory secondary password is available in case the user's password has been misplaced or forgotten. It can be obtained by contacting a DHI Authorized Service Center (see Table 25). The factory secondary password is different for all RPM4-E-DWT's and changes each time it is used.

3.9.6 <6PUNIT>

○ PURPOSE

To customize the selection of pressure units of measure available in the **[UNIT]** key menu.

○ PRINCIPLE

The **[UNIT]** function key makes available a choice of four default pressure units (psi, MPa, kPa, bar) (see Section 3.7.3). RPM4-E-DWT also supports many commonly used units other than those included in the default set up. These units can be made available for active selection by customizing the UNIT function using **[SPECIAL]**, **<6Punit>**. This allows RPM4-E-DWT to offer a very wide selection of units while simplifying day to day operation. The typical user customizes the **[UNIT]** function key to support his/her most commonly used units. Up to six units can be included in the **[UNIT]** screen.

○ OPERATION

To customize the **[UNIT]** function key, press **[SPECIAL]**, **<6Punit>** from the MAIN RUN screen. The display is:

1. Entry field to specify which unit position (1 to 6) of the **[UNIT]** function key menu is to be changed.

```

      1
      ↓
Set up unit #5
    
```

Enter the number of the unit position that you would like to change. The display becomes:

```
Unit#5  1SI  2other
        3altitude 4user
```

Select the desired pressure unit category (SI units include units *based* on SI units such as mmHg), then select the desired unit from the unit menu. **<3altitude>** is not available in this RPM4-E-DWT model.

The units of measure available are listed in Table 6.

Table 6. UNIT function - available units of measure

<1SI>	<2OTHER>	<3ALTI TITUDE >	<4USER>
<1Pa> <2hPa> <3kPa> <4MPa> <5mbar> <6bar> <7mmHg> <8mmWa>	<1psi> <2psf> <3inHg> <4inWa> <5kcm2>	Not available in this RPM4-E-DWT model	

If **<4user>** is selected, the user unit must be defined. The display is:

```
Define user unit:
1.000000 unit/Pa
```

1. Entry field.



Enter the number of user units per Pascal (Pa) in the entry field. Pressing **[ENT]** defines the user unit and returns to the **<Set up unit #n>** screen.



The user defined unit label can be customized to any alphanumeric, four character label using the remote command "UDU" (see Section 4.4).



See Section 7.1.1 for the pressure unit conversion factors used by RPM4-E-DWT.

3.9.7 <7INTERN>

○ PURPOSE

To view, set, adjust, and maintain various aspects of RPM4-E-DWT's internal operation.

○ OPERATION

To access the internal selections press **[SPECIAL]**, **<7intern>**. The display is:

```
1baro 2ReadRt 3RPT2x
4lo vnt 5log
```

The INTERNAL menu choices include:

<1baro> View the real time output of the RPM4-E-DWT on-board barometer (see Section 3.9.7.1).

<2ReadRt> Turn ON and OFF RPM4-E-DWT's automated, rate of change dependent, reading and integration and display rate feature (see Section 3.9.7.2).

<3RPT2x> Feature not used in this RPM4-E-DWT model.

<4lo vnt> Feature not used in this RPM4-E-DWT model.

<5log> View the RPM4-E-DWT incident log (see Section 3.9.7.5).

3.9.7.1 <1BARO>

○ PURPOSE

To view the value of atmospheric pressure as measured by the RPM4-E-DWT on-board barometer.

○ PRINCIPLE

RPM4-E-DWT A70M/A7M-AF is equipped with an on-board barometer. The atmospheric pressure measurements made by the on-board barometer are used for dynamic compensation of atmospheric pressure when making gauge pressure measurements (see Sections 3.9.1).



See Section 5.5.4 Figure 14 and Section 5.5.6, Figure 15 for a photo and schematics showing the position of the on-board barometer in RPM4-E-DWT.



The on-board barometer is a low accuracy sensor used only for measuring small changes in atmospheric pressure over short periods of time (see Section 3.9.1). RPM4-E-DWT measurement uncertainty does not depend on the measurement uncertainty of the on-board barometer.

○ OPERATION

To view the current reading of the on-board barometer press **[SPECIAL]**, **<7intern>**, **<1baro>**. The display is in the active pressure unit of measure (see Section 3.7.3). The display resolution is fixed to 0.1 Pa, or its equivalent.

3.9.7.2 <2READRT>

○ PURPOSE

To turn ON and OFF RPM4-E-DWT's automated, rate of change dependent, reading integration and display rate feature.

○ PRINCIPLE

To obtain maximum resolution from RPM4-E-DWT Q-RPT pressure measurements, an integration time of about 1.2 second per reading is used. In most situations, maximum precision is needed when pressures are stable so a relatively slow display update rate presents no disadvantage. However, when pressure is changing quickly, more rapid pressure updates are usually more important than obtaining maximum precision on individual readings. The RPM4-E-DWT read rate function automatically adjusts pressure measurement integration time depending on the rate of change of pressure. When pressure is changing rapidly, reading rate is increased. When pressure is evolving slowly, reading rate is decreased and maximum precision is obtained.

When the automated read rate function is ON, three pressure rate of change dependent read rates are used. The result is three display update rates:

Table 7. READRT – display update rates

PRESSURE RATE OF CHANGE	DISPLAY UPDATE
> 3 % of range span/s	≈ 0.2 s
> 0.5 and < 3 % of range span/s	≈ 0.6 s
< 0.5 % of range span/s	≈ 1.2 s

For situations in which maximum reading precision is desired regardless of pressure rate of change, the RPM4-E-DWT automated read rate function can be turned OFF.

In this case, the reading rate is always the high resolution rate of about 1.2 readings per second.

○ OPERATION

To turn the automated read rate function ON or OFF or check its current status, press **[SPECIAL]**, **<7intern>**, **<2ReadRt>**.

The display is:

Auto read rate: 1on 2off

The cursor is on the current selection.

Selecting **<1on>** activates the automated reading rate and returns to the MAIN RUN screen. Selecting **<2off>** turns OFF the automated reading rate and returns to the MAIN RUN screen.

The default RPM4-E-DWT condition is auto read rate ON.



Auto read rate ON/OFF is NOT Q-RPT or range specific. Turning auto read rate ON or OFF in one range turns it ON or OFF for all RPM4-E-DWT ranges.

3.9.7.3 <3RPT2x>

○ PURPOSE

This feature is not used in this RPM4-E-DWT model.

3.9.7.4 <4LO VNT>

○ PURPOSE

This feature is not used in this RPM4-E-DWT model.

3.9.7.5 <5LOG>

○ PURPOSE

To view and/or clear the RPM4-E-DWT event log.

○ PRINCIPLE

RPM4-E-DWT records to a log each time one of the following events occurs:

- **Pmax! of an internal RPM4-E-DWT Q-RPT is exceeded (see Section 3.8.4.1).**
- **A memory fault occurs.**

○ OPERATION

To view the event log press **[SPECIAL]**, **<7intern>**, **<5log>**. The oldest logged event appears. Pressing the left or right arrow keys, **[<]** or **[>]**, steps through the logged events from the oldest to the most recent and ending with the option to clear the log, **<1no>**, **<2yes>**. The log clear choice is not available in all security levels (see Section 3.9.5.5, Table 5). Pressing the down arrow key displays the number of the event and the date and time the event occurred.

When all events have been viewed, **<End of log>** displays.

3.9.8 <8CAL>

○ PURPOSE

To calibrate the RPM4-E-DWT Hi and Lo Q-RPTs and adjust the on-board barometer. These functions are considered part of RPM4-E-DWT maintenance and are covered in the maintenance section of this manual (see Sections 5.2.2, 5.2.2).

3.9.9 <9RESET>

○ PURPOSE

To reset various RPM4-E-DWT settings to default or factory values.

○ PRINCIPLE

RPM4-E-DWT stores its user definable settings in non-volatile memory. The reset menu allows the user to selectively or completely reset these settings to factory defaults. This clears any settings that the user has made, and should be used only to restore the RPM4-E-DWT to a known state. RPM4-E-DWT goes through its power up sequence after any type of reset is executed.



RPM4-E-DWT reset functions will change current settings to factory defaults. These may include settings vital to RPM4-E-DWT operation and affecting the calibration of the reference pressure transducers (RPTs). Reset functions should only be used by qualified personnel with knowledge of reset consequences. Reset functions should never be used “experimentally”.

○ OPERATION

To access the RESET menu, press **[SPECIAL]**, **<9reset>**. The display is:

1sets 2units 3ATest 4cal 5all

RESET menu choices include:

- <1sets>** to reset general system operating parameters (see Section 3.9.9.1).
- <2units>** to reset unit of measure functions (see Section 3.9.9.2).
- <3ATest>** to reset AutoTest parameters, clear File AutoTest files and clear the AutoTest data log (see Section 3.9.9.3).
- <4cal>** to reset internal calibration coefficients and modes (see Section 3.9.9.4).
- <5all>** to reset all settings except ID and security password to factory default values (see Section 3.9.9.5).

3.9.9.1 <1SETS>

○ PURPOSE

Sets most general operating parameters back to default values. Does not affect calibration coefficients, remote interfaces or AutoRange ranges. The Reset – Sets resets are itemized in Table 8.

Table 8. Reset – Sets

RESET	RESULT	SEE SECTION
[UNIT]	Pressure unit of measure to first of the six available	3.7.3
[RANGE]	Hi Q-RPT default range	3.7.2
[HEAD]	0 in height and Oil medium	3.7.8, 3.9.3
Stability Limit	0.01 % of Hi Q-RPT default range	3.8.3
Upper Limit	Hi Q-RPT default range default value	3.8.4
Resolution	0.01 % FS of Hi Q-RPT default range	3.8.2
AutoZ	AutoZ ON for all Q-RPTs, Z_{offset} value not affected	3.9.1
AutoZ	$P_{atm,0}$ set to 101.325 kPa a	3.9.1
Leak Check	15 second run time. Clear logged results	3.7.6
Screen Saver	10 minutes to activation	3.9.5.1
Key Sounds	Medium tone valid key press sound	3.9.5.2
Lo Vnt	Automatic	None
ReadRate	Automatic	3.9.7.2

3.9.9.2 <2 UNITS>

○ PURPOSE

Sets the pressure units available under the UNIT function to default selections depending (see Section 3.7.3).

Sets the user defined unit to 1.000/Pa (see Section 3.9.6).

Sets the reference temperature for inWa unit to 20°C.

3.9.9.3 <3ATEST>

○ PURPOSE

- Resets Auto Tests to default characteristics (see Section 3.7.11).
- Clears File AutoTest definition files (see Section 3.8.5.2).
- Clears AutoTest results data logs (see Section 3.8.5.1).

3.9.9.4 <4 CAL>

○ PURPOSE



The Reset - Cal function will reset the Q-RPT and barometer calibration coefficients and reset AutoZ values to zero. This will change the RPM4-E-DWT calibration and could cause it to make out of tolerance measurements.

Clears all user values affecting the calibration of Q-RPTs and the on-board barometer. The Reset – Cal resets are itemized in Table 9.

Table 9. Reset – Cal

RESET	RESULT	SEE SECTION
All Q-RPT Calibration Coefficients	PA to zero, PM to 1	5.3.1.1
On-board Barometer Calibration Coefficients	PA to zero, PM to 1	5.2.2
Calibration Date	Set all dates to 19800101	5.3.7, 5.2.2
AutoZ value	101325 Pa Gxxx, BGxxx Q-RPTs: All P _{offset} values to zero	3.9.1
AutoZ function	ON, all Q-RPTs	3.9.1

3.9.9.5 <5 ALL>

○ PURPOSE



The reset - all function clears and deletes large amounts of user defined information including critical calibration data.

Combines all resets in one global reset command that clears the entire user section of non-volatile memory except the ID function (see Section 3.9.5.4) and the security level password (see Section 3.9.5.5) returning RPM4-E-DWT to the “as delivered” condition. The Reset – All resets are itemized in Table 10.

Table 10. Reset – All

RESET	RESULT	SEE SECTION
Reset – Sets	All the resets of Reset - Sets	3.9.9.1
Reset – Units	All the resets of Reset - Units	3.9.9.2
Reset – Atest	All the resets of Reset - ATest	3.9.9.3
Reset – Cal	All the resets of Reset - Cal	3.9.9.4
Remote Interfaces	COM1, COM2 interfaces to default settings.	3.9.2
Remote Communications	Remote command format to Classic	3.9.2.3
Level (Security)	Reset security level to low	3.9.5.5



4. REMOTE OPERATION

4.1 OVERVIEW

Most of the RPM4-E-DWT front panel functions can also be executed by commands from a remote computer. The host computer can communicate with the RPM4-E-DWT using the RPM4-E-DWT's COM1 RS232 port.

Before writing code using RPM4-E-DWT remote commands, familiarize yourself with its operating principles by reviewing Section 3 of this manual.

4.2 INTERFACING

Sending a program message to the RPM4-E-DWT places it into **remote** mode. The remote indicator to the right of the display window lights when the RPM4-E-DWT is in **remote** mode. It also flickers when a program message is received. The menus usually accessed from the front panel are locked out while in remote. The **[ESC]** key returns the RPM4-E-DWT to local operation unless the **<REMOTE>** program message, which locks out all keypad operation, was sent to the unit.

4.2.1 RS232 INTERFACE

4.2.1.1 COM1

The RPM4-E-DWT COM1 RS232 interface is located on the back of the unit. It is a 9-pin male DB-9F connector configured as a DCE device. Data is transmitted out of the unit using pin 2, and is received on pin 3. This allows a normal pin-to-pin DB-9M to DB-9F RS232 cable to be used to connect to a DTE host.

Handshaking is not required or supported. The COM1 receive buffer is 80 bytes deep. If you overflow the buffer by sending too much data, the data will be lost. Because of this, you **must** send a single program message at a time and you **must** wait for the RPM4-E-DWT to reply from the previous command before issuing another command.

Table 11. COM1 pin designations and connections

RPM4-E-DWT COM1 DB-9F PIN DESIGNATIONS		
PIN #	FUNCTION	DESCRIPTION
2	TxD	This pin transmits serial data from the RPM4-E-DWT to the host.
3	RxD	This pin accepts serial data from the host computer.
5	Grn	This pin is the common return for the TxD and RxD signals.

IBM PC/XT DB-9F CONNECTIONS		IBM PC/XT DB-9M TO RPM4-E-DWT DB9F CONNECTION	
DB-25M	DB-9F	DB-9M	DB-9F
2	3	3	3
3	2	2	2
7	5	5	5

4.2.1.2 COM2

The RPM4-E-DWT COM2 RS232 interface is located on the back of the unit. It can be used to allow the host computer to communicate with another device through the RPM4-E-DWT. This allows the user to use one host COM port to communicate with the RPM4-E-DWT and an additional RS232 device. Refer to the “#” remote program command for details.

COM2 is a 9-pin female DB-9F connector configured as a DTE device. Data is transmitted out of the RPM4-E-DWT using pin 3, and is received on pin 2. This allows a normal pin-to-pin DB-9M to DB-9F RS232 cable to be used to connect to a DCE device.

Handshaking is not required or supported.

Table 12. COM2 DB-9F pin designations

PIN #	FUNCTION	DESCRIPTION
2	RxD	This pin transmits serial data from the RPM4-E-DWT to a device.
3	TxD	This pin accepts serial data from the external device.
4	DTR	This pin is Data Terminal Ready (DTR) (held at + 5 V).
5	Grn	This pin is the common return for the TxD and RxD signals.

4.3 PROGRAMMING FORMATS

RPM4-E-DWT supports two program message formats, the “**classic**”, and the “**enhanced**” formats. The user must select which format to use. Selection can be accomplished from the front panel (see Section 3.9.2.3) or remotely using the “**L2**” or “**L3**” program message (see Section 4.4.4). The “**MSGFMT**” command can also be used to select the format, but is not recommended for new designs.

The main difference between the “classic” and “enhanced” formats is that commands that reply a Boolean type reply a ‘0’ or ‘1’ when in enhanced mode. Classic mode includes the original command in the reply.

Many RPM4-E-DWT classic and enhanced commands are common with **DHI** PPC Pressure/Controller Calibrators.

4.3.1 PROGRAM MESSAGE FORMAT

Each program message sent is also a query. You can only send one program message to the RPM4-E-DWT at time. The command can be followed with an optional query operator “?” if desired, but it is not mandatory. After sending any program message, you must wait for the RPM4-E-DWT to reply before sending another program message. This reply will contain data, or a numeric error message if the program message was invalid. You must wait for this reply before issuing another program message to the RPM4-E-DWT. This insures that the RPM4-E-DWT has completed the program message. Most remote program messages will return a reply within 500 ms except:

“PR?”, “PRR?”, “SR?”, “ATM?”, “RATE?”: Up to 2 seconds.

“RPT”, “ARANGE”, “AUTOZERO=RUN”: Up to 3 seconds

The syntax and format used for each program message in the classic mode is listed next to the keyword “Classic” in each program message summary in Section 4.4.4. The format for the enhanced mode is also indicated where needed.

4.3.2 ERROR QUEUE

The RPM4-E-DWT keeps track of remote errors by using an error queue. If an error occurs, the reply to the offending command will be "ERR#nn" where nn is the error code from 0 to 99. The text description of the error is pushed onto the Error Queue. You should always check the reply for an error and handle as needed. The "ERR?" (or "ERR") query can then be used to pull the error from the Error Queue in it's descriptive text format. If you are using the enhanced program message format, the Error Queue will accumulate errors until full unless they are pulled from the queue. If you are using the classic program format, the Error Queue is cleared every time a new program message is received

Examples:

- **COM1 enhanced mode command:**

"*CLS" or **"*CLS?"** (Clear the error queue. Wait for reply)

"UNIT KPA" or **"UNIT? KPA"** (Generates a reply. User must wait for reply before continuing)

"MMODE A" or **"MMODE? A"** (Generates a reply. User must wait for reply before continuing)

"PR" or **"PR?"** (Generates a reply. User must wait for reply before continuing)

4.3.2.1 USING QUERY TYPE COMMANDS

The QUERY type of program message just requests data from the RPM4-E-DWT.

Placing the query operator "?" immediately after the command is optional. All commands generate a reply that you must wait for and receive before sending the next command. Most queries return a reply within 200 ms except:

"PR?", "PRR?", "SR?", "ATM?", "RATE?": Up to 2 seconds.

"RPT", "ARANGE", "AUTOZERO RUN": Up to 3 seconds

The syntax for using a QUERY program message is listed next to the keyword **"Query:"** in each program message summary in Section 4.4.4.

4.4 COMMANDS

4.4.1 PROGRAMMING MESSAGES

Some commands accept an optional suffix. This suffix can be used to specify the explicit Q-RPT to address. In most cases, each Q-RPT in the RPM4-E-DWT operates as an independent measurement device. If the suffix is not specified, then the “Active” Q-RPT is assumed.

The “RANGE” or “ARANGE” command can be used to select the “Active” Q-RPT. See the program message descriptions for suffix use with a specific command.

Table 13. Program message list

COMMAND 'n' indicates an optional suffix	DESCRIPTION
#	Send a command string out of the RPM4-E-DWT COM2 port.
ABORT	Stop pending operations.
ARANGEn	Read or set a new AutoRange to use.
ATM	Read the current atmospheric pressure (on-board barometer).
AUTOZEROn	Read or set the status of the AutoZ automatic zeroing function.
AUTOZEROn=RUN	Run AutoZero.
CALAMB	Read or set the on-board barometer calibration.
COM1	Read or set the configuration of the COM1 port.
COM2	Read or set the configuration of the COM2 port.
CONTn	Enable continuous measurements.
DATE	Read or set the current date.
ERR	Read the last error message.
HEAD	Read or set the fluid head settings.
ID	Read or set the RPM4-E-DWT alphanumeric asset ID tag.
L2	Selects “classic” program message format.
L3	Selects “enhanced” program message format.
LOCAL	Return control to the RPM4-E-DWT front panel.
MEM	Read the power-up memory test status.
MSGFMT	Read or set the type of program message format to use.
PCALn	Read or set the user Lo Q-RPT calibration information.
PCAL:XX	Read or set the user Lo Q-RPT calibration information (old command).
PRn	Read the next RPM4-E-DWT pressure.
PRRn	Read the next RPM4-E-DWT pressure, rate, and ATM.
QPRRn	Read the last RPM4-E-DWT pressure, rate and ATM.
RANGE	Select a Q-RPT to be “active” in its default full scale range.
RATEn	Read the next available rate of change of pressure.
READRATEn	Read or set the Q-RPT measurement read rate and mode.
READYCKn	Read or set a flag that is cleared by a <i>Not Ready</i> condition.
REMOTE	Enable remote local lockout operation.
RESn	Read or set the pressure display resolution for the current Q-RPT and range.
RESET	Reset the RPM4-E-DWT to default user parameters.
RPTn	Read the available Q-RPT data.
SCRSAV	Read or set the front panel screen saver period.
SN	Read the serial number of the RPM4-E-DWT.
SRn	Read the next available pressure status (<i>Ready/Not Ready</i>).
SSn	Read or set the stability required for a <i>Ready</i> condition.
SS%n	Read or set the stability required for a <i>Ready</i> condition (% span/ s).
TIME	Read or set the current time of day.
UCOEFn	Convert a pressure in Pascal to pressure in the current units.
UDU	Read or set the user defined pressure unit.
ULn	Read or set the upper limit for the current range.
UNITn	Read or set the pressure unit of measure for the current range.
VER	Read the RPM4-E-DWT software version.
ZOFFSETn	Read or set the AutoZero Z_{offset} for the specified Q-RPT.
ZOFFSET:XX	Read or set the AutoZ Z_{offset} for the specified Q-RPT (old command).

4.4.2 ERROR MESSAGES

Table 14. Error #s and descriptions

REPLY	DESCRIPTION
ERR# 0	"OK"
ERR# 2	"Text argument is too long"
ERR# 3	"Arguments cannot be 0"
ERR# 4	"External device not detected"
ERR# 5	Not used
ERR# 6	"Numeric argument missing or out of range"
ERR# 7	"Missing or improper command argument(s)"
ERR# 8	"External device time-out error"
ERR# 9	"Unknown command"
ERR# 10	"Missing or invalid command suffix"
ERR# 11	"Command missing argument"
ERR# 12	"System overpressured" or "overpressure may result"
ERR# 13	"Text queue overflow"
ERR# 14	"User unit not defined"
ERR# 17	Not used
ERR# 18	"Command not yet available"
ERR# 19	"Not available with absolute units"
ERR# 20	"Not available with gauge device"
ERR# 21	Not used
ERR# 22	"Pressure is not stable"
ERR# 23	"Option not available or installed"
ERR# 25	Not used
ERR# 26	"COM port failed to initialize"
ERR# 27	"Internal device failure"
ERR# 28	"Device failure"
ERR# 29	"Device not available"
ERR# 30	"Must be on range HI"
ERR# 31	"Exceeds upper or lower limit"
ERR# 32	"Not stable enough"
ERR# 37	"Data table is full"
ERR# 38	"Selected range is not available"
ERR# 39	"Data verify error"
ERR# 45	"Argument not allowed"
ERR #46	"Argument cannot be negative"
ERR #52	"Command obsolete"
ERR# 53	"Not Available"

4.4.3 PROGRAM MESSAGE DESCRIPTION OVERVIEW

Each program message description is separated into the following sections:

Purpose	A brief description of the programs message's function.
Command	This is the Enhanced program message syntax to send data to the RPM4-E-DWT or to execute an RPM4-E-DWT function. The RPM4-E-DWT must be set to use the enhanced format (see Section 3.9.2.3) to use the syntax and style shown. It may be sent alone, or followed by at least one white space and additional argument(s) to show that arguments can be passed. If there are multiple arguments, then commas must separate them. The RPM4-E-DWT will reply and you must wait for this reply. If this field is not listed in the program message description, then the Command type is not supported when using the Enhanced format.
Query	This is the Enhanced program message syntax to request data from the RPM4-E-DWT. The RPM4-E-DWT must be set to use the enhanced format (see Section 3.9.2.3). The RPM4-E-DWT will always reply to a query. You must wait for this reply before issuing another program message. If this field (Query) is not listed in the program message description, then the Query type for the program message is not supported when using the Enhanced format.
Classic	This is the Classic program message syntax to send data to the RPM4-E-DWT, to execute an RPM4-E-DWT function, or to query for data. The RPM4-E-DWT must be set to use the classic format (see Section 3.9.2.3). The command may be followed by a '(=)' and additional argument characters to show that argument(s) can be passed. If there are multiple arguments, then commas must separate them. The RPM4-E-DWT will always reply to a program message. You must wait for this reply before issuing another program message. If this field is not listed in the program message description, then it is not supported when using the classic format.
Suffix	Some commands support an optional suffix. This suffix is used to specify a Q-RPT to which the command applies, since many settings are Q-RPT specific: Suffix of '1' for Hi Q-RPT access Suffix of '2' for Lo Q-RPT access If an optional suffix is allowed but not given, then the "Active Q-RPT" will be addressed. The "Active Q-RPT" is the Q-RPT that is currently displayed on the top line of the front panel of the RPM4-E-DWT, and is identified by the text label in the upper right of the pressure display screen. The last Q-RPT ranged or selected using the "RANGE" or "ARANGE" commands is the "Active" Q-RPT. The "ARANGE", "RANGE" or "RPT" command query can be used to determine which Q-RPT is currently active.
Arguments	If the program message can be used to set data inside the RPM4-E-DWT, then this section describes the arguments and their limits.
Default	If the program message can be used to set data inside the RPM4-E-DWT, then this line shows (using the enhanced format) the default setting from the factory.
Remarks	This field has the details and remarks about the command.
Example	Examples are given for the enhanced and classic methods. Enhanced: An example of the use of an enhanced format program message to be sent to the RPM4-E-DWT is shown. The message sent to the RPM4-E-DWT appears after the " Cmd sent: " label. If only a Query type exists, the " Query sent: " label is shown instead. Directly under this label, " Query reply " shows a typical reply to a query type. " Reply: " shows that a query format does not exist. It may have a short description next to it. Classic: An example of the use of a classic program message to be sent to the RPM4-E-DWT is shown. The command sent to the RPM4-E-DWT appears after the " Cmd sent: " label. The " Reply " label shows a typical reply to the " Sent " example. It may have a short description next to it.
Errors	If the program message can report an argument error, the types of errors are listed. The error message is replied after receiving the program message. The " ERR " or " ERR? " query can be used to retrieve a text description of the error.
See Also	Indicates related commands ("----") and refers to manual sections giving detail on RPM4-E-DWT operation corresponding to the program message.

4.4.4 PROGRAM MESSAGE DESCRIPTIONS

#	
Purpose	To allow the host PC to communicate with a device connected to the RPM4-E-DWT COM2 port.
Classic	"#xx"
Arguments	xx: The string to send out of the RPM4-E-DWT COM2 port. It must be less than 40 characters long.
Remarks	The RPM4-E-DWT COM2 port can be used to communicate to another RS232 device (such as another RPM4-E-DWT). This allows the user to use a single COM port or IEEE-488 port on the host computer to communicate with the RPM4-E-DWT and another RS232 device. A carriage return and a line feed (<CR><LF>) are added to the string. After this program message is issued, the RPM4-E-DWT will reply back every string received by the RPM4-E-DWT COM2 port that is terminated with a carriage return. Line feeds are discarded. This will discontinue when the next query is sent to the RPM4-E-DWT. There is no other reply from this program message. Prior to using this program message, you must ensure that the RPM4-E-DWT COM2 port is correctly set up to communicate with the device on COM2. Refer to the " COM2= " program message.
Example (classic)	Sent: "#VER" Reply: "DH INSTRUMENTS RPM4-E-DWT us A70M/A7M Ver1.00 " This example assumes that a second RPM4-E-DWT's COM1 port is connected to the RPM4-E-DWT COM2 port. This example gets the version of the second RPM4-E-DWT.
See Also	"COM2" 3.9.2

ABORT	
Purpose	Cancels any pending data requests by the "PR", "PRR", "RATE", "SR" or "CONT" commands.
Command Classic	"ABORT" "ABORT"
Remarks	This program message is usually used to ensure the RPM4-E-DWT is in an idle condition.
Example (enhanced)	Cmd sent: "ABORT" Reply: "ABORT" (no reply if IEEE-488)
Example (classic)	Sent: "ABORT" Reply: "ABORT"
See Also	"PR", "PRR", "RATE", "SR", "CONT"

ARRANGEn	
Purpose	Read or set a new AutoRange range to use.
Command	"ARRANGE n Range, unit, mode (<i>RptLabel</i>)" (set to user defined range) "ARRANGE Q-RPTLabel" (set to Q-RPT default range)
Query	"ARRANGE?"
Classic	"ARRANGE= Range, units, mode (<i>RptLabel</i>)" (set to user defined range) "ARRANGE= Q-RPTLabel" (set to Q-RPT default range)
Query	"ARRANGE"
Optional Suffix	" n " A suffix may be used instead of " <i>RptLabel</i> " '1' Specify the Hi Q-RPT '2' Specify the Lo Q-RPT
Arguments	<i>Range</i> : The AutoRange maximum pressure. Cannot be negative. <i>Unit</i> : The unit of measure of the <i>Range</i> argument. <i>Mode</i> : The measurement mode of the <i>Range</i> argument: "G" for gauge <i>RptLabel</i> : One of the Q-RPTs that is available. (optional) "IH": Hi Q-RPT if the Hi and Lo Q-RPTs are NOT OFF. HL Q-RPT if the Hi and Lo Q-RPTs are OFF. "IL": Lo Q-RPT "HL": HL Q-RPT.
Remarks	<p>The ARRANGE command is used to define an RPM4-E-DWT range by specifying a desired unit of measure, measurement mode and maximum pressure, and have the RPM4-E-DWT pick the best available Q-RPT and make adjustments to optimize operation in that range.</p> <p>The optional suffix or the "<i>RptLabel</i>" argument can be used to specify which Q-RPT you wish to use for the AutoRange range instead of allowing the RPM4-E-DWT to pick the best Q-RPT. By using this option you can override the internal logic that picks the most suitable Q- Q-RPT. This Q-RPT specified must be valid for the maximum pressure and measurement mode specified.</p> <p>The reply indicates the current range data, including the Q-RPTLabel used for the range.</p> <p>If "inWa" is specified for the unit, the temperature reference can be given after the unit text ("inWa4", "inWa20" or "inWa60" corresponding to inWa at 4 °C, 20 °C or 60 °F). If no number is given, a default of 20 °C is assumed. There is no indication of the temperature reference in the reply.</p> <p>If you just specify the Q-RPTLabel without any other arguments, the Q-RPT specified will become active in it's last range and settings. The previously set unit and measurement mode for the Q-RPT specified will become active.</p>
Example (enhanced)	Cmd sent: "ARRANGE?" (read the current range in the current units) Query reply: "100.00, psi, G, IH"
Example (classic)	Cmd sent: "ARRANGE" Query reply: "100.00, psi, G, IH"
Example (enhanced)	Cmd sent: "ARRANGE? 250, inWa4, G (range of 250 inWa @ 4 °C in gauge mode) Query reply: "250.00 inWa, G, IH" (Lo Q-RPT is used)
Example (classic)	Cmd sent: "ARRANGE=500, kPa, G (range of 500 kPa in gauge mode) Query reply: "500.00 kPa, G, IL" (Lo Q-RPT is used)
Example (enhanced)	Cmd sent: "ARRANGE2 50, psi, G (range of 50 psi in gauge mode on the Lo Q-RPT) Query reply: "50.000 psi, G, IL"
Example (enhanced)	Cmd sent: "ARRANGE IH (Hi Q-RPT's prev range made active) "500.000 kPa, A, IH" Query reply:
Errors	ERR# 6: " <i>Range</i> " maximum pressure exceeds available Q-RPTs or is negative. ERR#10: RPT specified by the optional suffix is not valid for the current operating conditions ERR# 20: Cannot Range to '0' with gauge units. ERR# 29: Correct type of Q-RPT for the selected " <i>Mode</i> " is not available. ERR# 53: RPT specified is not available.
See Also	"RPT", "RANGE", "UNIT" 3.7.5, .3.1.1, 3.7.3

ATM	
Purpose	Reads the next measured pressure from RPM4-E-DWT's on-board barometer (if present).
Query Classic	"ATM?" "ATM"
Remarks	The atmospheric pressure as measured by the RPM4-E-DWT on-board barometer is returned in the current pressure units of the active Q-RPT (always absolute). This measurement is followed by the units text. Not all RPM4-E-DWTs are equipped with an on-board barometer.
Example (enhanced)	Query sent: "ATM?" Query reply: "97.12348 kPa a"
Example (classic)	Sent: "ATM" Reply: "97.12384 kPa a"
Errors	ERR# 23: RPM4-E-DWT is not equipped with a barometer.
See Also	3.9.7.1

AUTOZEROn	
Purpose	Read or set the status of the AutoZ function.
Command Query	"AUTOZEROn state" "AUTOZEROn?"
Classic	"AUTOZEROn= state" "AUTOZEROn"
Default	"AUTOZERO1"
Optional Suffix	"n" A suffix may be used instead of " <i>RptLabel</i> " '1' Specify the Hi Q-RPT '2' Specify the Lo Q-RPT
Arguments	'state': '0' Autozero OFF '1' Autozero ON
Remarks	The RPM4-E-DWT AutoZ function can be turned ON and OFF.
Example (enhanced)	Cmd sent: "AUTOZERO 0" Query reply: "0" (No reply if GPIB-488)
Example (classic)	Sent: "AUTOZERO=0" Query reply: "AUTOZERO=0"
Errors	ERR# 7: The argument was other than '0' or '1'. ERR# 10: The suffix is invalid.
See Also	"ZOFFSET" 3.9.1

AUTOZEROn=RUN	
Purpose	Run the AutoZero routine.
Command Query	"AUTOZEROn RUN (,Pref)" "AUTOZEROn? RUN (,Pref)"
Classic	"AUTOZEROn= RUN (,Pref)"
Optional Suffix	"n" A suffix may be used instead of " <i>RptLabel</i> " '1' Specify the Hi Q-RPT '2' Specify the Lo Q-RPT
Arguments	'Pref': The AutoZ reference pressure in Pa. Optional when the RPM4-E-DWT is not in absolute measurement mode, as the reference is usually "0".
Remarks	The RPM4-E-DWT AutoZ function can be remotely run with this command only if AutoZero is ON. You should ensure that the pressure is stable for valid determination of Z_{offset} .
Example (enhanced)	Cmd sent: "AUTOZERO RUN" Query reply: "OK" (No reply if GPIB-488)
Example (enhanced)	Cmd sent: "AUTOZERO? RUN, 0" Query reply: "OK"
Example (classic)	Sent: "AUTOZERO=RUN" Query reply: "OK"
Errors	ERR# 10: Invalid suffix ERR# 53: AutoZero is currently OFF.
See Also	"ZOFFSET", "AUTOZERO" 3.9.1, 3.7.10

CALAMB	
Purpose	Read or set the on-board barometer calibration.
Command	"CALAMB <i>adder, mult, CalDate</i> "
Query	"CALAMB?"
Classic	"CALAMB= <i>adder, mult, CalDate</i> " "CALAMB"
Defaults	"CALAMB = 0.0, 1.0, 19800101"
Arguments	<i>Adder</i> : The Barometer calibration adder (PA), in Pascal. <i>Mult</i> : The Barometer calibration multiplier (PM) from 0.1 to 100. <i>CalDate</i> : The date of the calibration in the format "YYYYMMDD"
Remarks	The barometer calibration information can be accessed with this program message. Using this program message overwrites the current calibration coefficients, so caution must be used. Changes made take effect immediately.
Example (enhanced)	Cmd sent: "CALAMB? 2.1, 1.000021, 20011201" Query reply: " 2.10, 1.000021, 20011201"
Example (classic)	Sent: "CALAMB=2.1, 1.000021, 20011201" Reply: " 2.10, 1.000021, 20011201"
Errors	ERR# 6: One of the arguments is out of range.
See Also	3.9.7.1, 5.2.2

COM1	
Purpose	Read or set the RS232 settings for the COM1 port.
Command	"COM1 <i>baud, parity, data, stop</i> "
Query	"COM1?"
Classic	"COM1= <i>baud, parity, data, stop</i> " "COM1"
Arguments	<i>Baud</i> : The baud rate. This may be '300', '600', '1200', '2400', '4800', '9600' or '19200'. <i>Parity</i> : The data parity. This may be 'O' for odd, 'E' for even, or 'N' for none. <i>Data</i> : The number of data bits. This may be '7' or '8'. <i>Stop</i> : The number of stop bits. This may be '1' or '2'.
Defaults	"COM1 2400,E,7,1"
Remarks	The COM1 port is used to communicate to the RPM4-E-DWT. When the COM1 port configuration of the RPM4-E-DWT is changed, the program message reply (COM1 use only) is sent at the old COM1 settings, but all subsequent communications are accomplished at the new COM1 settings. A 250ms or longer delay after receiving the reply to this command will ensure that the RPM4-E-DWT has changed the COM port settings and is ready for communications at the new settings.
Example (enhanced)	Cmd sent: "COM1 9600,N,8,1" Query reply: "9600,N,8,1" (No reply if GPIB-488)
Example (enhanced)	Cmd sent: "COM1? 9600,N,8,1" Query reply: "9600,N,8,1"
Example (classic)	Sent: "COM1=9600,N,8,1" Reply: "9600,N,8,1"
Errors	ERR# 7: Missing or improper program message argument(s).
See Also	"COM2" 3.9.2.1

COM2	
Purpose	Read or set the RS232 settings for the COM2 port.
Command	"COM2 <i>baud,parity,data,stop</i> "
Query	"COM2?"
Classic	"COM2= <i>baud,parity,data,stop</i> " "COM2"
Arguments	<i>baud</i> : The baud rate. This may be '300', '600', '1200', '2400', '4800', '9600' or '19200'. <i>parity</i> : The data parity. This may be 'O' for odd, 'E' for even, or 'N' for none. <i>Data</i> : The number of data bits. This may be '7' or '8'. <i>stop</i> : The number of stop bits. This may be '1' or '2'.
Defaults	"COM2 2400,E,7,1"
Remarks	COM2 is generally used to allow the host computer to communicate through the RPM4-E-DWT to an additional device connected to COM2. This can be useful if the host computer does not have 2 serial ports available.
Example (enhanced)	Cmd sent: "COM2 9600,N,8,1" Query reply: "9600,N,8,1" (No reply if GPIB-488)
Example (enhanced)	Cmd sent: "COM2? 9600,N,8,1" Query reply: "9600,N,8,1"
Example (classic)	Sent: "COM2=9600,N,8,1" Reply: "9600,N,8,1"
Errors	ERR# 7: Missing or improper program message argument(s).

See Also	"COM1" 3.9.2.1
----------	-------------------

CONTn	
Purpose	Have the RPM4-E-DWT reply continuously as each new measurement becomes available.
Query	"CONT n ?"
Classic	"CONT n "
Optional Suffix	" n " A suffix may be used instead of " <i>RptLabel</i> " '1' Specify the Hi Q-RPT '2' Specify the Lo Q-RPT
Remarks	This command is somewhat different than most as it enables the RPM4-E-DWT to continuously output the selected Q-RPT's measurement without further queries. This continues until the next query is received by the RPM4-E-DWT, or if the ABORT" or "CLS" command is received. The frequency of the measurements is determined by the read rate of the Q-RPT. The data returned includes the pressure of the specified or active Q-RPT, current unit of measure and measurement mode.
Example (enhanced)	Query sent: "CONT1?" Query reply: "1936.72 kPa a" (repeats every measurement cycle)
Example (classic)	Query sent: "CONT" Reply: "1936.72 kPa a" (repeats every measurement cycle)
See Also	"PR", "READRATE"

DATE	
Purpose	Read or set the RPM4-E-DWT date.
Command	"DATE <i>date</i> "
Query	"DATE?"
Classic	"DATE= <i>date</i> " "DATE"
Arguments	<i>date</i> : The date in the numerical only format "YYYYMMDD"
Remarks	The RPM4-E-DWT has an internal real time calendar clock. The span of acceptable dates ranges from 19800101 to 20791231. The reply is always in the YYYYMMDD format.
Example (enhanced)	Cmd sent: "DATE 20030115" Query reply: "20030105" (No reply if GPIB-488)
Example (enhanced)	Cmd sent: "DATE? 20030105" Query reply: "20030105"
Example (classic)	Sent: "DATE=20021201" Reply: "20021201"
Errors	ERR# 6: Missing or improper program message argument(s).
See Also	"TIME" 3.9.5.3

ERR	
Purpose	Read the new available error message from the Error Queue.
Query	"ERR?"
Classic	"ERR"
Remarks	This program message obtains additional details about an error that has occurred. If the user receives an "ERR# nn" reply, or the enhanced mode is enabled using the IEEE-488 interface and an error has been detected, the error is put into a FIFO Error Queue. The "ERR" program message pulls and replies the oldest error message available. In "classic" mode only the most recent error can reside in the queue. "OK" is replied if there are no error messages left. If an error occurs in enhanced mode using the IEEE-488 interface, no reply is generated even if the command was a query.
Example (enhanced):	Query sent: "ERR?" Query reply: "Numeric argument missing or out of range"
Example (classic)	Sent: "ERR" Reply: "Numeric argument missing or out of range"
See Also	4.4.2

HEAD	
Purpose	Read or set the fluid head settings.
Command Query	"HEAD <i>height, units, fluid</i> " "HEAD?"
Classic	"HEAD= <i>height, units, fluid</i> " "HEAD"
Defaults	"HEAD 0, cm, N2"
Arguments	<i>height:</i> The height of the test in relation to the RPM4-E-DWT. The value is positive if the test is above the RPM4-E-DWT, or negative if below the RPM4-E-DWT. The value can be between - 9999 and 9999. Setting the value to '0' disables the head correction. <i>Units:</i> The height units. This must be "in" or "cm". <i>gas:</i> The fluid type. This must be "N2", "Air", "He", "Oil", "H2O", or "User".
Remarks	The RPM4-E-DWT can make a fluid head correction to allow it to display the pressure at a level other than the reference level of the RPM4-E-DWT.
Example (enhanced)	Cmd sent: "HEAD? 10,in,N2" Query reply: "10, in, N2"
Example (classic)	Sent: "HEAD=10,in,N2" Reply: "10, in, N2"
Errors	ERR# 2: The fluid text is too long ERR# 6: The height is not within given limits or the unit is invalid. ERR #7: The fluid text is invalid
See Also:	3.7.8, 3.9.3

ID	
Purpose	Read or set the user defined instrument identification label.
Command Query	"ID <i>string</i> " "ID"
Classic	"ID= <i>string</i> " "ID"
Arguments	<i>String:</i> An alphanumeric string up to 12 characters long.
Remarks	The user defined ID label can be used to allow the user to "tag" the RPM4-E-DWT with a unique identifier. This ID is stored in non-volatile memory and cannot be erased by a power failure, system fault or reset. The ID should not be changed frequently, as the non-volatile memory may fail after 100,000 write operations.
Example (enhanced)	Cmd sent: "ID RPM4-E-DWT #A01" Query reply: "RPM4-E-DWT #A01" (No reply if GPIB-488)
Example (enhanced)	Cmd sent: "ID? RPM4-E-DWT #A01" Query reply: "RPM4-E-DWT #A01"
Example (classic)	Sent: "ID=RPM4-E-DWT #A01" Reply: "RPM4-E-DWT #A01"
Errors	ERR# 2 Text argument is too long (more than 12 characters)
See Also	3.9.5.4

L2 / L3	
Purpose	Read or set the type of program command format to use (classic or enhanced).
Command	"L2" enables "classic" mode "L3" enables "enhanced" mode
Defaults	"L2" (Classic mode)
Remarks	The user can select the type of remote command format using these simplified commands. There is no query format. This format must agree with the format sent to the RPM4-E-DWT. This command is a replacement for the "MSGFMT" command.
Example (enhanced)	Cmd sent: "L3" Query reply: "L3"
Example (classic)	Sent: "L2" Reply: "L2"
See Also	"MSGFMT" 4.3, 3.9.2.3

LOCAL	
Purpose	Returns control to the RPM4-E-DWT front panel.
Command	"LOCAL"
Classic	"LOCAL"
Remark	The REMOTE program message can lock the front panel out completely. The user can return to local operation by sending the LOCAL program message, sending the IEEE-488 'GTL' command (if in enhanced format), or by cycling RPM4-E-DWT power.
Example (enhanced)	Cmd sent: "LOCAL" Reply: "LOCAL" (no reply if IEEE-488)
Example (enhanced)	Cmd sent: "LOCAL?" Reply: "LOCAL"
Example (classic)	Sent: "LOCAL" Reply: "LOCAL"
See Also	"REMOTE"

MEM	
Purpose	Read the status from the power-up memory test.
Query	"MEM?"
Classic	"MEM"
Remarks	The RPM4-E-DWT system memory stores the user settings (units, resolution) and retains them when the unit is OFF. On power-up, this memory is checked. If this memory is corrupted, all user settings are reset to default, and the MEM status is set to reflect this.
Example (enhanced)	Query sent: "MEM?" Reply: "0" RPM4-E-DWT data corrupted and was set to factory defaults. "1" The memory was found to be OK on power-up.
Example (classic)	Sent: "MEM" Reply: "MEM=0" RPM4-E-DWT data corrupted and was set to factory defaults. "MEM=1" The memory was found to be OK on power-up.
See Also	3.9.9, 3.9.7.5

MSGFMT	
Purpose	Read or set the type of program command format to use (enhanced or classic).
Command	"MSGFMT <i>mode</i> "
Query	"MSGFMT?"
Classic	"MSGFMT= <i>mode</i> " "MSGFMT"
Arguments	<i>mode</i> : '1' to use the enhanced command format. '0' to use the classic command format.
Defaults	"MSGFMT 0"
Remarks	The user can select the type of remote command format to use. This format must agree with the format sent to the RPM4-E-DWT The enhanced query form of this command ("MSGFMT? <i>n</i> ") should always be used to set the desired format, as it will be accepted regardless of the current format (classic or enhanced). It is recommended to use the "L2" and "L3" commands instead of this command for new designs.
Example (enhanced)	Cmd sent: "MSGFMT 1" Query reply: "1" (No reply if IEEE-488)
Example (enhanced)	Cmd sent: "MSGFMT? 1" Query reply: "1"
Example (classic)	Sent: "MSGFMT=1" Reply: "MSGFMT=1"
Errors	ERR# 6: Missing or improper program message argument(s).
See Also	"L2 / L3" 4.3, 3.9.2.3

PCALn	
Purpose	Read or set the calibration information for the Hi or Lo Q-RPT.
Command Query	"PCAL n <i>adder, mult, CalDate</i> " "PCAL n ?"
Classic	"PCAL n = <i>adder, mult, CalDate</i> " "PCAL n "
Defaults	"PCAL n = 0.0, 1.0, 19800101"
Optional Suffix	" n " The active Q-RPT is assumed if no suffix is given. The Hi Q-RPT is assumed if the HL Q-RPT is active and no suffix is given. '1' Specify the Hi Q-RPT '2' Specify the Lo Q-RPT
Arguments	<i>Adder</i> : The Q-RPT calibration adder (PA). In Pascal. <i>Mult</i> : The Q-RPT calibration multiplier (PM) from 0.1 to 100. <i>CalDate</i> : The date of the calibration in the format "YYYYMMDD" by default. Any other format up to 8 characters long is also accepted, and the replied format is in the previously entered format.
Remarks	The user defined pressure calibration information for the specified Q-RPT (Hi or Lo) can be accessed with this program message. Using this program message overwrites the current calibration coefficients, so caution must be used. Changes made using this program message take effect immediately. For compatibility with the obsolete style PPC3 "PCAL:HI" and "PCAL:LO" commands, ":HI" and ":LO" can be used in place of the suffix " n " but this is not recommended for new applications.
Example (enhanced)	Cmd sent: "PCAL2? 2.1, 1.000021, 20011201" Query reply: " 2.10 Pa, 1.000021, 20011201" (No reply if GPIB-488)
Example (enhanced)	Cmd sent: "PCAL? 2.1, 1.000021, 20011201" Query reply: " 2.10 Pa, 1.000021, 20011201"
Example (enhanced)	Cmd sent: "PCAL:HI? 2.1, 1.000021, 20011201" (PPC3 style is OK) Query reply: " 2.10 Pa, 1.000021, 20011201"
Example (classic)	Sent: "PCAL1=2.1, 1.000021, 20011201" Reply: " 2.10 Pa, 1.000021, 20011201"
Errors	ERR# 6: One of the arguments is out of range. ERR# 10: The suffix is invalid.
See Also	5.2.2

PRn	
Purpose	Read the next available pressure measurement.
Query	"PR n ?"
Classic	"PR n "
Optional Suffix	" n " A suffix may be used instead of " <i>RptLabel</i> " '1' Specify the Hi Q-RPT '2' Specify the Lo Q-RPT
Remarks	The next available pressure value for the specified or active Q-RPT is read in the current pressure units. The data returned also contains <i>Ready/Not Ready</i> information, and the pressure unit of measure and measurement mode. The reply field is always 20 characters long. The first 3 characters of the reply are reserved for the ready status. The ready status is described in the "SR" program message. The pressure value and pressure unit of measure are right justified in this field. After receiving this program message, the RPM4-E-DWT replies back with the data after a new pressure measurement cycle is complete. This can take up to the current read rate period (1.2 seconds by default).
Example (enhanced)	Query sent: "PR?" Query reply: "R 1936.72 kPa g"
Example (classic)	Query sent: "PR" Reply: "R 1936.72 kPa g"
See Also	"PRR", "QPRR", "SR", "ABORT", "READRATE" 3.6.1, 3.1.2, 3.9.7.2

PRR	
Purpose	Read the next available <i>Ready</i> condition, pressure measurement, rate and on-board barometer reading.
Query	"PRR?"
Classic	"PRR"
Optional Suffix	"n" A suffix may be used instead of " <i>RptLabel</i> " '1' Specify the Hi Q-RPT '2' Specify the Lo Q-RPT
Remarks	The next available <i>Ready</i> condition, Q-RPT pressure measurement, rate of pressure change, and barometric pressure is replied in the current pressure unit of measure. . This can take up to the current read rate period (1.2 seconds by default). Each data field is separated by a comma, and is returned in the following order: ready, pressure UNITS, rate UNITS/s, atm UNITS Here are the field descriptions: ready: Three character ready status field. Refer to the "SR" command. pressure: The measured pressure for the active Q-RPT in the current pressure unit. This is followed by the current pressure unit. rate: The measured rate of pressure change for the active Q-RPT in the current pressure unit per second. This is followed by the current pressure unit of measure. atm: The pressure measured by the RPM4-E-DWT on-board barometer in the current pressure unit (and always absolute). This is followed by the current pressure unit.
Example (enhanced)	Query sent: "PRR?" Query reply: "R,2306.265 kPag,0.011 kPa/s,97.000 kPa g"
Example (classic)	Query sent: "PRR" Reply: "R,2306.265 kPag,0.011 kPa/s,97.000 kPa g"
See Also	"PR", "QPRR", "SR" 3.6.1, 3.1.2, 3.9.7.1

QPRR	
Purpose	Read the last Q-RPT pressure measurement, pressure rate and on-board barometer output immediately.
Query	"QPRR?"
Classic	"QPRR"
Optional Suffix	"n" A suffix may be used instead of " <i>RptLabel</i> " '1' Specify the Hi Q-RPT '2' Specify the Lo Q-RPT
Remarks	The last measured <i>Ready/Not Ready</i> condition, active Q-RPT pressure measurement, rate of pressure change, and barometric pressure is replied in the current pressure unit of measure immediately. This program message is useful when a rapid response of measured pressure is needed. It does not result in quicker pressure measurements. Each data field is separated by a comma, and is returned in the following order: Ready, pressure UNITS, rate UNITS/s, atm UNITS Here are the field descriptions: ready: Three character ready status field. Refer to the "SR" command. pressure: The measured pressure for the selected Q-RPT in the current pressure unit. This is followed by the current pressure unit and measurement mode. rate: The measured rate of pressure change for the active Q-RPT in the current unit of pressure per second. This is followed by the current pressure unit. atm: The pressure measured by the RPM4-E-DWT on-board barometer in the current pressure unit (but always absolute). This is followed by the current pressure unit.
Example (enhanced)	Query sent: "QPRR?" Query reply: "R,2306.265 kPa g,0.011 kPa/s,97.000 kPa g" "R,2306.265 kPa g,0.011 kPa/s" (no barometer)
Example (classic)	Query sent: "QPRR" Reply: "R,2306.265 kPa g,0.011 kPa/s,97.000 kPa g"
See Also	"PR", "PRR", "SR" 3.6.1, 3.1.2, 3.9.7.1

RANGE	
Purpose	Change the active range to the default range of the Hi or Lo Q-RPT. Replies the active range full scale, pressure unit and measurement mode.
Command Query	"RANGE <i>Rng</i> " "RANGE?"
Classic	"RANGE= <i>Rng</i> " "RANGE "
Default	"RANGE IH" <i>Rng</i> : "IH" for the Hi Q-RPT "IL" for the Lo Q-RPT
Remarks	The active Q-RPT must be selected before making changes to settings that are dependent on the range. Q-RPTs selected with this command are used with their full default pressure range. The reply indicates the active range in psi. Used as a simple query, the active range is returned, which can be an AutoRanged range or a default range (see "ARANGE" cmd).
Example (enhanced)	Cmd sent: "RANGE? IL" (select internal Lo Q-RPT in it's full default range) Query reply: "1000 psi g,IL"
Example (classic)	Sent: "RANGE= IH" (select internal Hi Q-RPT in it's full default range) Reply: "10000 psi g, IH"
Example (classic)	Sent: "RANGE" (request current range) Reply: "1000 psi g,IL"
Errors	ERR# 6: Invalid <i>Rng</i> argument. ERR# 29: The selected Q-RPT is not available.
See Also	"ARANGE", "RPT" 3.1.1, 3.7.2, 3.7.5

RATEn	
Purpose	Read the next available pressure rate of change.
Query	"RATE n ?"
Classic	"RATE n "
Optional Suffix	" n " A suffix may be used instead of " <i>RptLabel</i> " '1' Specify the Hi Q-RPT '2' Specify the Lo Q-RPT
Remarks	The next available pressure rate of change in the current pressure unit per second is returned. After receiving this program message, the RPM4-E-DWT replies back with the data once a new pressure measurement cycle is complete. This can take up to the current read rate period (1.2 seconds by default).
Example (enhanced)	Query sent: "RATE?" Query reply: "0.01 kPa/s"
Example (classic)	Sent: "RATE2" Reply: "0.03 kPa/s"
See Also	"PRR", "QPRR" 3.7.7.2

READRATEn	
Purpose	Read or set the specified or active Q-RPT read rate or auto read rate mode.
Command Query	"READRATE n <i>period</i> " "READRATE n ?"
Classic	"READRATE n = <i>period</i> " "READRATE n "
Optional Suffix	" n " A suffix may be used instead of " <i>RptLabel</i> " '1' Specify the Hi Q-RPT '2' Specify the Lo Q-RPT
Arguments	" <i>period</i> ": Period to integrate the measurement over (ms). Can be from 200 ms to 20000 ms. Set to '0' to enable automatic read rate.
Remarks	The RPM4-E-DWT can have the speed in which it integrates each measurement ("read rate") automatically adjusted based on the rate, or it can manually set to a fixed period. Increasing the read rate increases the reply time for pressure and rate queries.
Example (enhanced)	Cmd sent: "READRATE 1000" Query reply: "1000"
Example (enhanced)	Cmd sent: "READRATE? 1000" Query reply: "1000"
Example (classic)	Sent: "READRATE=1000" Reply: "1000"
Errors	ERR# 6: The " <i>period</i> " argument is out of range. ERR#10: The suffix ' n ' is invalid
See Also	"PR", "PRR", "SR" 3.9.7.2

READYCKn	
Purpose	Read or set the <i>Ready</i> check flag.
Command	"READYCK n 1"
Query	"READYCK n ?"
Classic	"READYCK n =1" "READYCK n "
Optional Suffix	" n " A suffix may be used instead of " <i>RptLabel</i> " '1' Specify the Hi Q-RPT '2' Specify the Lo Q-RPT
Remarks	The internal ready check flag is cleared whenever the specified or active Q-RPT reaches a <i>Not Ready</i> (NR) condition. The "READYCK" query returns the status of the flag. The flag is set by sending the "READYCK 1" program message while the Q-RPT is in a <i>Ready</i> condition. The "READYCK" program message query can then be used at a later time to determine whether a <i>Not Ready</i> condition has occurred since the ready check flag was set.
Example (enhanced)	Cmd sent: "READYCK1 1" Query reply: "1" (no reply if GPIB-488)
Example (enhanced)	Cmd sent: "READYCK1?" Query reply: "1"
Example (enhanced)	Cmd sent: "READYCK?" Query reply: "1" (if Q-RPT condition has stayed <i>Ready</i>) "0" (if Q-RPT condition has NOT stayed <i>Ready</i>)
Example (classic)	Sent: "READYCK=1" Query reply: "READYCK=1"
Example (classic)	Sent: "READYCK" Query reply: "READYCK=1" (if Q-RPT condition has stayed <i>Ready</i>) "READYCK=0" (if Q-RPT condition has NOT stayed <i>Ready</i>)
Errors	ERR# 6: Argument is not a '0' or a '1'.
See Also	"SR" 3.1.2

REMOTE	
Purpose	Lock out the front panel keypads during remote operation.
Command	"REMOTE"
Classic	"REMOTE"
Remarks	The RPM4-E-DWT goes into remote mode whenever communications take place. The user can return to local operation by pressing the [ESC] key. The REMOTE program message locks out the front panel completely. The only way to unlock the front panel after the "REMOTE" command is using the "LOCAL" program message, the IEEE-488 "GTL" command, or by cycling the RPM4-E-DWT power.
Example (enhanced)	Cmd sent: "REMOTE" Reply: "REMOTE" (no reply if IEEE-488)
Example (enhanced)	Cmd sent: "REMOTE?" Reply: "REMOTE"
Example (classic)	Sent: "REMOTE" Reply: "REMOTE"
See Also	"LOCAL"

RESn	
Purpose	To read or set the pressure display resolution for the active range.
Command	"RES n <i>res</i> "
Query	"RES n "
Classic	"RES n = <i>res</i> " "RES n "
Default	"RES n =0.001"
Optional Suffix	" n " A suffix may be used instead of " <i>RptLabel</i> " '1' Specify the Hi Q-RPT '2' Specify the Lo Q-RPT
Arguments	<i>res</i> : The pressure display resolution in % span of the specified Q-RPT range (0.0001 to 1 % FS).
Remarks	The pressure display resolution is defined as % span of the active range. The setting is separate for each range, and changes as the range is changed.
Example (enhanced)	Cmd sent: "RES .01" Query reply: "0.01" (No reply if GPIB-488)
Example (enhanced)	Cmd sent: "RES? .01" Query reply: "0.01"
Example (classic)	Sent: "RES=.01" Reply: "0.01"
Errors	ERR# 6 The argument is invalid.
See Also	3.8.2

RESET	
Purpose	Reset the user's settings to factory defaults.
Command	"RESET"
Classic	"RESET"
Remarks	The RPM4-E-DWT has user settings (units, resolution, etc.) that can be reset to factory defaults. The remote "RESET" program message corresponds to the front panel "Reset - Sets". System calibration coefficients and communications settings are not affected. The reset cycle takes up to 3 seconds to complete. Remote communications should not take place during this period.
Example (enhanced)	Cmd sent: "RESET" Reply: "RESET" (no reply if IEEE-488)
Example (enhanced)	Cmd sent: "RESET?" Reply: "RESET"
Example (classic)	Sent: "RESET" Reply: "RESET"
See Also	3.9.9.1

RPTn	
Purpose	Read the available Q-RPT identification data.
Query	"RPTn"
Classic	"RPTn"
Optional Suffix	"n" A suffix may be used instead of " <i>RptLabel</i> " '1' Specify the Hi Q-RPT '2' Specify the Lo Q-RPT
Remarks	Two internal Q-RPTs are available for use in an RPM4-E-DWT. You can query the RPM4-E-DWT for information about each particular Q-RPT. The Q-RPT data is returned in the following format: <i>RPTLabel</i> , Q-RPTLocator, Serial#, RngGa, RngAbs, Q-RPTMode RngLabel: RPT type label. This label identifies the Q-RPT type and range. This is the same label used on the RPM4-E-DWT front panel screen. RptLocator: Text field identifying the Q-RPT position in the RPM4-E-DWT system. "IH" identifies this as an internal, Hi Q-RPT "IL" identifies this as an internal, Lo Q-RPT Serial#: The serial number of the Q-RPT. RngGa: The Q-RPT default gauge mode range in the current pressure unit. RngAbs: The Q-RPT default absolute mode range in the current pressure unit. "NONE" appears in the field if the Q-RPT is a Gxxx, BGxxx or Axxx with absolute and negative gauge modes OFF. RptMode: 'G' if Q-RPT is gauge Gxxx or Axxx with absolute and negative gauge modes OFF and supports only gauge measurement mode.
Example (enhanced)	Cmd sent: "RPT2?" (Get information on the Lo Q-RPT) Query reply: "A7M, IL, 82345, 1000, NONE,G"
Example (classic)	Cmd sent: "RP1" (Get information on the HL Q-RPT) Query reply: "A70M, HL, 82349, 10000, NONE,G"
Errors	ERR#4: External device not detected. ERR# 10: Invalid suffix.
See Also	3.1.1

SCRSV	
Purpose	Read or set the front panel display screen saver activation time.
Command	"SCRSV n"
Query	"SCRSV?"
Classic	"SCRSV=n" "SCRSV"
Arguments	n: The inactivity period (0 – 99 minutes) after which screen saver activates.
Default	"SCRSV 10"
Remarks	The RPM4-E-DWT front panel will dim after a period of keyboard and remote inactivity. Setting this value to '0' disables this feature.
Example (enhanced)	Cmd sent: "SCRSV 30" Query reply: "30" (No reply if GPIB-488)
Example (enhanced)	Cmd sent: "SCRSV? 30" Query reply: "30"
Example (classic)	Sent: "SCRSV=30" Reply: "30"
Errors	ERR# 6 The argument was invalid.
See Also	3.9.5.1

SN	
Purpose	To read the serial number of the RPM4-E-DWT.
Query	"SN?"
Classic	"SN"
Remarks	The RPM4-E-DWT is serialized. The serial number can be read using this program message.
Example (enhanced)	Query sent: "SN?" Query reply: "321"
Example (classic)	Sent: "SN" Reply: "321"
See Also	3.9.5.4

SR	
Purpose	Read the next available <i>Ready/Not Ready</i> status.
Query	"SR?"
Classic	"SR"
Optional Suffix	" <i>n</i> " A suffix may be used instead of " <i>RptLabel</i> " '1' Specify the Hi Q-RPT '2' Specify the Lo Q-RPT
Remarks	The current <i>Ready</i> status can be read using this program message. Possible replies: "NR" The pressure is not ready within the limits defined by the stability criterion. "R " The pressure meets the ready criteria. The status is replied when the next pressure measurement is finished. "OL" The pressure of one of the active Q-RPTs has exceeded the user defined upper or lower limits. "OP" The pressure of one of the Q-RPTs has exceeded the Q-RPT's maximum limits. "ER" An internal device failure has occurred.
Example (enhanced)	Query sent: "SR?" Query reply: "NR"
Example (classic)	Sent: "SR" Reply: "NR"
See Also	"PR", "PRR", "HS", "SS", "UL" 3.1.2, 3.8.4, 3.8.4.1

SS%<i>n</i>	
Purpose	Read or set the current stability limit as a % of range.
Command	"SS% <i>limit</i> "
Query	"SS%?"
Classic	"SS%= <i>limit</i> " "SS%"
Optional Suffix	" <i>n</i> " A suffix may be used instead of " <i>RptLabel</i> " '1' Specify the Hi Q-RPT '2' Specify the Lo Q-RPT
Arguments	<i>limit</i> : The stability limit in %FS of the current active range.
Remarks	The stability limit can be read and set as a percent of the full scale range of the Q-RPT range.
Example (enhanced)	Cmd sent: "SS% .1" Query reply: "0.10 %"(No reply from GPIB-488)
Example (enhanced)	Cmd sent: "SS%? .1" Query reply: "0.10 %"
Example (classic)	Sent: "SS%=.1" Reply: "0.10 %"
Errors	ERR# 6: The argument was invalid. ERR# 10: Invalid or missing command suffix.
See Also	"SS" 3.8.3, 3.1.2

SSn	
Purpose	Read or set the current pressure stability limit.
Command	"SS <i>limit</i> "
Query	"SS?"
Classic	"SS= <i>limit</i> " "SS"
Optional Suffix	"n" A suffix may be used instead of " <i>RptLabel</i> " '1' Specify the Hi Q-RPT '2' Specify the Lo Q-RPT
Arguments	<i>Limit</i> : The stability limit in the current pressure unit of measure.
Remarks	The stability limit can be read and set as a pressure. The stability limit is used as the <i>Ready/Not Ready</i> criteria..
Example (enhanced)	Cmd sent: "SS .1" Query reply: "0.10 psi/s"
Example (enhanced)	Cmd sent: "SS? .1" Query reply: "0.10 psi/s"
Example (classic)	Sent: "SS=.1" Reply: "0.10 psi/s"
Errors	ERR# 6: The argument was invalid. ERR# 10: Invalid or missing command suffix.
See Also	"SS%" 3.8.3, 3.1.2

TIME	
Purpose	Read or set the RPM4-E-DWT internal clock.
Command	"TIME <i>hh:mmXX</i> "
Query	"TIME?"
Classic	"TIME= <i>hh:mmXX</i> " "TIME"
Arguments	<i>hh:mm</i> : The time in a 12 hour format using a colon delimiter <i>XX</i> : "am" or "pm"
Example (enhanced)	Cmd sent: "TIME 12:52PM" Query reply: "12:52pm" (No reply if GPIB-488)
Example (enhanced)	Cmd sent: "TIME? 12:52PM" Query reply: "12:52pm"
Example (classic)	Sent: "TIME=12:52PM" Reply: "12:52pm"
Errors	ERR# 7: Missing or improper program message argument(s).
See Also	"DATE" 3.9.5.3

UCOEFn	
Purpose	To identify the coefficient used to convert 1 Pascal to the current pressure unit of measure.
Query	"UCOEFn?"
Classic	"UCOEFn"
Optional Suffix	"n" A suffix may be used instead of " <i>RptLabel</i> " '1' Specify the Hi Q-RPT '2' Specify the Lo Q-RPT
Remarks	The RPM4-E-DWT handles all pressure values internally in Pascal. The coefficient replied is equivalent of 1 Pa in the current pressure unit of measure. This program message allows the user to convert pressures
Example (enhanced)	Query sent: "UCOEF?" Query reply: "0.0010000000"
Example (classic)	Sent: "UCOEF" Reply: "0.0010000000"
See Also	3.7.3, 3.9.6, 7.1.1

UDU	
Purpose	Read or set the user defined pressure unit.
Command Query	"UDU <i>label, ucoef</i> " "UDU?"
Classic	"UDU= <i>label, ucoef</i> " "UDU" <i>label</i> : User unit label (4 alphanumeric char maximum). It cannot be an already supported unit label. <i>Ucoef</i> : "User unit conversion coefficient (units/Pa).
Default	"UDU USER,1.0"
Remarks	The user defined unit must be set up with the program message prior to remote or local selection.
Example (enhanced)	Cmd Sent: "UDU MYUN, .001" Query reply: "MYUN, 0.001000" (No reply if GPIB-488)
Example (enhanced)	Cmd Sent: "UDU? MYUN, .001" Query reply: "MYUN, 0.001000"
Example (enhanced)	Sent: "UDU=MYUN, .001" Reply: "MYUN, 0.001000"
Errors	
See Also	3.9.6, 3.7.3

ULn	
Purpose	Read or set an upper limit for the specified or active Q-RPT.
Command Query	"ULn <i>limit</i> " "ULn?"
Classic	"ULn= <i>limit</i> " "ULn"
Optional Suffix	" <i>n</i> " A suffix may be used instead of " <i>RptLabel</i> " '1' Specify the Hi Q-RPT '2' Specify the Lo Q-RPT
Arguments	" <i>limit</i> ": The upper limit pressure in the specified Q-RPT's current pressure unit and measurement mode.
Remarks	The RPM4-E-DWT has an upper limit for each range and for each measurement mode (gauge, absolute, and differential). If the pressure does exceed the upper limit, the pressure display flashes. This feature should always be used to prevent accidental over pressure of a device under test.
Example (enhanced)	Cmd sent: "UL 1000" Query reply: "1000.00 kPa g"
Example (enhanced)	Cmd sent: "UL? 1000" Query reply: "1000.00 kPa g"
Example (classic)	Sent: "UL=1000" Reply: "1000.00 kPa g"
Errors	ERR# 6: The " <i>limit</i> " argument is out of range.
See Also	3.8.4

UNITn	
Purpose	Read or set the pressure unit of measure.
Command	"UNIT n unit (<i>, ref</i>)"
Query	"UNIT n ?"
Classic	"UNIT n =unit (<i>, ref</i>)" "UNIT n "
Optional Suffix	" n " A suffix may be used instead of " <i>RptLabel</i> " '1' Specify the Hi Q-RPT '2' Specify the Lo Q-RPT
Arguments	<i>Unit</i> : The text corresponding to the pressure unit of measure. <i>ref</i> : The optional unit reference temperature only if the unit is "InWa"
Remarks	This program message determines what unit of measure is used to display pressure values. Refer to Table 6 for a detailed list of the units available and their labels. If the unit specified is "InWa", an optional second argument " <i>ref</i> " can be set. The " <i>ref</i> " can be 4, 20, or 60 corresponding to InWa at 4 °C, 20 °C or 60 °F. If this second argument is not given when the unit is "InWa", then the reference temperature is assumed to be 20 °C. This can also be added directly onto the end of the <i>Unit</i> argument if desired. The fifth character of the reply is always 'g' for gauge mode. White spaces precede this character if needed. The temperature reference is added to the reply only if the unit is "InWa". The reply includes the measurement mode character in the fifth position, with a 'g' indicating gauge mode.
Example (enhanced)	Cmd sent: "UNIT? kPag" Query reply: "kPag" Sent: "UNIT? InWag, 4" Query reply: "inWag, 4" Sent: "UNIT? InWag60" Query reply: "inWag, 60"
Example (enhanced)	Cmd sent: "UNIT psi n" Query reply: "psi g" ('g' used to indicate both gauge & neg gauge modes)
Example (classic)	Sent: "UNIT=kPag" Reply: "kPag" Sent: "UNIT=InWag, 4" Reply: "inWag, 4"
Errors	ERR# 7: The <i>unit</i> is invalid. ERR# 6: The <i>ref</i> is invalid.
See Also	3.7.3, 3.9.6, 7.1.1

VER	
Purpose	Identify the RPM4-E-DWT, US or SI units, the Q-RPT labels and the software version.
Query	"VER?"
Classic	"VER"
Remarks	The software version of the RPM4-E-DWT can be read. This is useful for checking for the presence of the RPM4-E-DWT and for reference purposes. It indicates the internal Q-RPT(s) and software version.
Example (enhanced)	Query sent: "VER?" Query reply: "DH INSTRUMENTS RPM4-E-DWT4 us A70M/7M Ver1.00 "
Example (classic)	Query sent: "VER?" Query reply: "DH INSTRUMENTS RPM4-E-DWT us E-DWT A70M/7M Ver1.00 "
See Also	"ID", "*IDN?"

ZOFFSETn	
Purpose	Read or set the AutoZ pressure offset (P_{offset}) for the specified or active Q-RPT.
Command	"ZOFFSET n <i>GaOffset</i> , <i>AbsOffset</i> , <i>DifOffset</i> "
Query	"ZOFFSET n ?"
Classic	"ZOFFSET n = <i>GaOffset</i> , <i>AbsOffset</i> , <i>DifOffset</i> " "ZOFFSET n "
Defaults	"ZOFFSET n = 101325, 0.0, 0.0" Note : the <i>AbsOffset</i> , <i>DifOffset</i> are not used in this model.
Optional Suffix	" n " The active Q-RPT is assumed if no suffix is given. '1' ":HI" Specify the Hi Q-RPT '2' ":LO" Specify the Lo Q-RPT
Arguments	<i>GaOffset</i> : The Q-RPT pressure offset ("Poffset") for Gauge measurement mode (Pa). <i>AbsOffset</i> : The Q-RPT pressure offset for absolute measurement mode (Pa) <i>DifOffset</i> : The Q-RPT pressure offset for differential measurement mode (Pa) Note : the <i>AbsOffset</i> , <i>DifOffset</i> are not used in this model.
Remarks	The pressure offset (P_{offset}) for the specified Q-RPT (Hi or Lo) can be accessed with this program message. There are separate offsets for gauge, absolute and differential measurement modes, but this RPM4-E-DWT model does not use the " <i>AbsOffset</i> " or " <i>DifOffset</i> ". Using this program message overwrites the current offset, so caution must be used. Changes made using this program message take effect immediately.
Example (enhanced)	Cmd sent: "ZOFFSET1 2.1, 0, 0" Query reply: " 97293.10 Pa, 0.00 Pa, 0.00 Pa"
Example (classic)	Sent: "ZOFFSET=97293.1, 0, 0" Reply: " 97293.10, 0.00, 0.00"
Errors	ERR# 6: One of the arguments is out of range.
See Also	3.9.1

NOTES

5. MAINTENANCE, ADJUSTMENTS AND CALIBRATION

5.1 OVERVIEW

E-DWT-10000-AF was designed for maintenance free operation. No maintenance is required other than:

- Regular AutoZeroing of quartz reference pressure transducers (Q-RPTs) (see Sections 3.9.1, 3.7.10).
- Periodic calibration of Q-RPTs (see Section 5.2.2).
- Adjustment of the on-board barometer (see Section 5.2.2).
- Overhaul of the E-DWT (see Section 5.4.1).

From a maintenance, calibration and repair point of view, the RPM4-E-DWT reference pressure monitor and the rest of the E-DWT are treated as separate sub-systems.



E-DWT-10000-AF is a sophisticated pressure measuring instrument with advanced on-board features and functions. Before assuming that unexpected behavior is caused by a system defect or failure, use this manual and other training facilities to become thoroughly familiar with E-DWT operation.

For rapid assistance in specific situations see Chapter 6 for troubleshooting information.



Unauthorized service or repair of E-DWT-10000-AF during the warranty period is undertaken at the owner's risk and may cause damage that is not covered under warranty and/or may void the warranty. For warranty service, contact a DHI Authorized Service Provider (see Table 25).

5.2 RPM4-E-DWT MAINTENANCE

The only regular maintenance of the RPM4-E-DWT is day to day zeroing of the Q-RPTs (see Section 5.2.1), regular recalibration of the Q-RPTs (see Section 5.2.2) and adjustment of the on-board barometer (see Section 5.2.2).

5.2.1 AUTOZERO OF Q-RPTS

See Sections 3.9.1 and 3.7.10 for complete information on Autozeroing of Q-RPTs.

The RPM4-E-DWT should be AutoZeroed prior to running each test.

Before AutoZeroing, allow at least two minutes for full system stabilization. Be sure that the pressure applied is truly zero (i.e., the E-DWT TEST port is open to atmosphere).

To cause the range to Autozero, press **[AutoZ]**.

5.2.2 ADJUSTMENT OF THE ON-BOARD BAROMETER

○ PURPOSE

To adjust the output of the on-board barometer (see Section 3.9.7.1).

○ PRINCIPLE

The on-board barometer output can be adjusted using PA and PM values following the same principles as for the Q-RPTs (see Section 5.3.1.1).

Since the on-board barometer is not a source of traceable pressure values, it does not have to be formally calibrated. It should be offset to agree with a reference barometer. To offset the barometer, change the barometer pressure adder (PA).



The on-board barometer is used only for measuring changes in atmospheric pressure over short periods of time (see Section 3.9.1). RPM4-E-DWT measurement uncertainty does NOT depend on the absolute accuracy of the on-board barometer.

○ OPERATION

To view or edit the values of PA and PM for RPM4-E-DWT's on-board barometer, press **[SPECIAL]**, **<8cal>**, **<3barometer>**. Pressing **[ENT]** steps through displays of the calibration date [YYYYMMDD] and PA and PM. In **edit** mode, the values can be edited. Pressing **[ENT]** after the last screen activates the edited values.



*To view the current output of the on-board barometer, press **[SPECIAL]**, **<7intern>**, **<3baro>** from the main run screen.*



A pressure standard may be connected to the on-board barometer by connecting to one of the ATM ports on the RPM4-E-DWT rear panel Q-RPT modules (10-32 UNF). The operating span of the barometer is 10 psi (70 kPa) to 16 psi (110 kPa).



Never apply a pressure greater than 16 psi (110 kPa) to the barometer port. Overpressure and possible damage may result.

5.3 RPM4-E-DWT Q-RPT CALIBRATION

5.3.1 PRINCIPLE

RPM4-E-DWT A70M/A7M-AF has two quartz reference pressure transducers (Q-RPTs) that are the source of low pressure measurement uncertainty for the system.

To adjust a Q-RPT, pressures from a reference standard are applied to the Q-RPT at ascending and descending pressure increments over the range. The pressure defined by the standard and the corresponding Q-RPT readings are recorded at each point. After all of the pressures have been applied and recorded, adjustments are made to fit the Q-RPT pressure readings to the standard. Fitting the readings means performing a least squares linear regression to arrive at the lowest value of the residuals of errors of the Q-RPT relative to the standard. The Q-RPT output is adjusted by user settable coefficients: PA (an adder or offset) and PM (a multiplier or span set) (see Section 5.3.1.1).

The calibration process is performed independently on each Q-RPT to arrive at its optimal fit.

RPM4-E-DWT is delivered with an interactive Q-RPT calibration utility (CalTool for RPTs) that steps the operator through the complete Q-RPT calibration procedure including applying the necessary pressures, collecting data automatically, calculating new PA and PM values, previewing the results of the new calibration and activating the results of the new calibration (see the CalTool for RPTs manual on the E-DWT-10000-AF Support Disk). The RPM4-E-DWT also provides complete front panel and remote access to Q-RPT calibration parameters so that Q-RPT calibrations can be performed without using CalTool software (see Section 5.3.7).



CalTool for RPTs software supports the calibration process of RPM4-E-DWT Q-RPTs. CalTool and its documentation are provided on the E-DWT-10000-AF Support Disk which is delivered with a new E-DWT-10000-AF. CalTool for RPTs can also be downloaded from www.dhstruments.com. The use of CalTool software to assist in the calibration of RPM4-E-DWT is highly recommended.

5.3.1.1 PA AND PM COEFFICIENTS

The coefficients used to adjust Q-RPT readings are designated PA (an adder or offset) and PM (a multiplier or span set). The coefficients affect the Q-RPT reading following:

$$\text{Corrected reading} = (\text{uncorrected reading} \cdot \text{PM}) + \text{PA}$$

PA is expressed in units of pressure (always the SI unit, Pascal).

PM is dimensionless.

Since the RPM4-E-DWT operates in gauge mode only and the Q-RPT is zeroed at the time of calibration and frequently rezeroed during calibration, PA should not be significantly different from zero.

Each Q-RPT has its own unique PA and PM values. The PA and PM values currently in use can be viewed and edited from the front panel in the CAL function (see Section 5.3.6). PA and PM values are automatically edited when CalTool software results are activated.



As editing PA and PM values changes Q-RPT calibration, they should only be edited by qualified personnel as part of the calibration process. Caution should be taken to avoid accidental editing, and a security system is available to prevent access (see Section 3.9.5.5). Incorrect editing of PA and PM values can cause out of tolerance measurements.



A new RPM4-E-DWT is delivered with PA and PM values set to zero and 1 for all Q-RPTs. This does not mean that the RPM4-E-DWT has not been calibrated. In the original factory calibration, privileged factory coefficients are used for calibration with the user PA and PM set to zero and 1.

5.3.2 EQUIPMENT REQUIRED



The recommended calibration standard for the RPM4-E-DWT A70M/A7M-AF Q-RPTs is a DHI PG7302 piston gauge. Contact DHI for additional information.

Oil operated piston gauge (deadweight tester), with the following characteristics:

- **Measurement uncertainty of ± 0.02 % of reading or better.** A standard with higher measurement uncertainty may be used but RPM4-E-DWT measurement uncertainty may be degraded proportionally from normal specifications.
- Able to supply the recommended sequence of pressure points in the range to be calibrated: See Section 5.3.4 for information on the recommended calibration point sequence.

5.3.3 SET-UP AND PREPARATION

To set-up and prepare the RPM4-E-DWT for calibration of its Q-RPTs:

 **THE RPM4-E-DWT SHOULD NOT BE REMOVED FROM THE E-DWT BRACKET FOR CALIBRATION. THE RPM4-E-DWT ONLY BE REMOVED FROM THE E-DWT WHEN DISASSEMBLY IS REQUIRED FOR MAINTENANCE OR REPAIR (see Section 5.5.1).**

Set the E-DWT-10000-AF on a stable surface near the calibration standard with its reference level (TEST port) as close as possible to the calibration standard's reference level. Consider the high pressure connection that needs to be made to the TEST port on the top of the E-DWT and access to the front panel display, keypad and Lo Q-RPT shut off valve.

Connect the calibration standard output to the E-DWT top TEST port. The TEST port connection is DH500 F (DH500 F: gland and collar type fitting for coned and left hand threaded 1/4 in. OD tube, equivalent to AE F250C, HIP HF4, etc.). The E-DWT TEST port connects to BOTH of the RPM4-E-DWT A70M/A7M-AF reference pressure transducers (see Section 3.4).

 **Take care to avoid overpressure of the Lo Q-RPT (A7M with maximum pressure of 1 000 psi). The E-DWT TEST port connects to both the A7M (1 000 psi) and the A70M (10 000 psi) Q-RPTs. Use the Lo Q-RPT Shut off valve on the E-DWT front panel to isolate the Lo Q-RPT when applying pressure to the Hi Q-RPT (see Section 3.4). If the RPM4-E-DWT is removed from the E-DWT, note that the RPM4-E-DWT has separate Lo and Hi TEST(+) ports, one for each Q-RPT. Exposing the Lo Q-RPT to pressure greater than 1 300 psi (9 MPa) may damage it beyond repair. The product warranty does not cover Q-RPT damage due to overpressure.**

5.3.4 RECOMMENDED CALIBRATION POINT SEQUENCE

Calibration adjustments to RPM4-E-DWT Q-RPTs are made by altering calibration coefficients, PA and PM (see Section 5.3.1.1). To adjust these coefficients to optimum values giving the best results over the Q-RPTs' complete operating range, the specific calibration point sequence defined in Table 15 is recommended.

Prior to running the calibration point sequence, the Q-RPT should be exercised:

- a) Set full scale pressure.
- b) Dwell at full scale pressure for 5 minutes.
- c) Return to atmospheric pressure (vented).
- d) Dwell for ten (10) minutes.

A dwell time of 60 seconds is recommended before taking data at each pressure increment.



The calibration pressure standard is not required to apply precisely the nominal pressure value of each calibration point as long as the exact value of the applied pressure is known. Best results are obtained if the actual applied pressure is within 5 % of the recommended nominal point.

Table 15. Calibration point sequence for A7M and A70M Q-RPTs

CALIBRATION SEGMENT	POINT NO.	POINT [% OF SPAN]
Ascending	1	0%*
	2	25 %
	3	50 %
	4	75 %
	5	100 %
Descending	6	75 %
	7	50 %
	8	25 %
	9	0%*

* AutoZ the RPM4-E-DWT with reservoir shut off valve close, TEST shut off valve open, TEST port open.

5.3.5 RPT CALIBRATION USING CALTOOL FOR Q-RPTS SOFTWARE

To calibrate RPM4-E-DWT Q-RPTs using CalTool software, refer to Sections 5.3.1, 5.3.2, 5.3.3 and 5.3.4 in this manual and then refer to the CalTool for Q-RPTs Software Manual.

CalTool for Q-RPTs software and manual are supplied on the E-DWT-10000-AF Support Disk and can be downloaded from www.dhstruments.com.

5.3.6 EDITING AND VIEWING Q-RPT CALIBRATION INFORMATION

○ PURPOSE

View and/or edit Q-RPT calibration information fields including:

- **The calibration date** – This field is normally used to record the date on which the Q-RPT is calibrated.
- **The value of absolute mode AutoZero P_{offset}** – Always 0 Pa. Not used in RPM4-E-DWT A70M/A7M-AF.
- **The value of PA** – The pressure adder for the selected Q-RPT (see Section 5.3.1.1).
- **The value of PM** – The pressure multiplier for the selected Q-RPT (see Section 5.3.1.1).

○ OPERATION



As editing PA and PM values will change the calibration of the Q-RPTs, the edit function should only be used by qualified personnel as part of the calibration process. Caution should be taken to avoid accidental editing. A user level security system is available to control access (see Section 3.9.5.5).



A new RPM4-E-DWT is delivered with PA and PM values set to zero and 1 for all ranges. This does not mean that the RPM4-E-DWT has not been calibrated. In the original factory calibration, privileged factory coefficients are used for calibration with the user PA and PM set to zero and 1.

To access Q-RPT calibration information viewing or editing press **[SPECIAL]**, **<8Cal>**. Select the desired Q-RPT. The **<1view>** selection displays the calibration information fields. The **<2edit>** function displays the fields and allows them to be edited. The display is:

1. Date of last calibration in YYYYMMDD format.
2. Position designator of the Q-RPT being viewed.
3. Current value of absolute mode P_{offset} .
Not used in RPM4-E-DWT A70M/A7M-AF. Always 0.0 Pa.

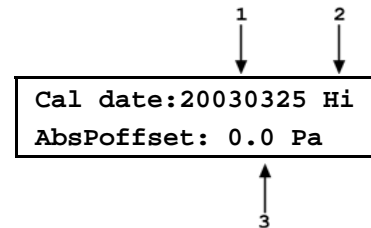

If in **edit** mode, the calibration information fields can be edited. Pressing **[ENT]** on the last field goes to the next view/edit screen:

1. Value of PA.
2. Position designator of the Q-RPT being viewed.
3. Value of PM.

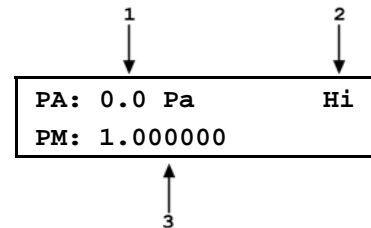

If in **edit** mode, the calibration fields can be edited. Pressing **[ENT]** on the **<PM>** field in view mode returns to the view/edit screen. **[ENT]** in edit mode goes to confirmation of change activation if changes have been made in any of the calibration screens. Pressing **[ESC]** in any edit screen exits the edit screen without activating any changes.



The value of PA is always in Pascal (Pa). The value of PM is dimensionless.

5.3.7 Q-RPT ADJUSTMENT WITHOUT CALTOOL FOR Q-RPTS SOFTWARE

○ PRINCIPLE

The RPM4-E-DWT Q-RPTs can be adjusted without using CalTool for Q-RPTs software. This requires:

- Zeroing the RPM4-E-DWT.
- Applying pressures with a calibration standard and recording the pressures measured by RPM4-E-DWT.
- Calculating new PA and PM values and entering them.



Before proceeding to adjust a Q-RPT without using CalTool for Q-RPTs software, Sections 5.3.1, 5.3.2, 5.3.3 and 5.3.4.

○ OPERATION

The typical procedure for adjusting a Q-RPT is:

- ❶ Set-up and prepare the RPM4-E-DWT for calibration (see Sections 5.3.2, 5.3.3).
- ❷ Use the **[RANGE]** function key to select the Q-RPT to be calibrated (see Section 3.7.2). Be sure to set the DF range (not an AutoRanged range).
- ❸ Use **[HEAD]** to set the HEAD to zero (see Section 3.7.8). Use **[UNIT]** to set the desired pressure unit of measure (see Section 3.7.3).

4 Use [SPECIAL], <8cal>, <1Hi Q-RPT > or <2Lo Q-RPT >, <1edit>, to read and record the current values of PA and PM for the Q-RPT to be calibrated.

5 AutoZ the RPM4-E-DWT with the reservoir shut off valve close, TEST shut off valve open and open to atmosphere at the E-DWT TEST port.

6 Run the recommended calibration point sequence for the Q-RPT (see Section 5.3.4). Record the pressure applied by the standard and the RPM4-E-DWT reading at each calibration point. Dwell at least 60 seconds at each point after setting the reference pressure to allow full stabilization.

7 Enter the calibration pressures and RPM4-E-DWT readings into a spreadsheet. Calculate the “non-corrected” RPM4-E-DWT readings by backing out the PM recorded in Steps 4 above, following:

non-corrected reading = corrected reading/PM [Note: PA should be 0]

8 Perform a linear regression to find the offset and slope that best fit the non-corrected RPM4-E-DWT readings to the calibration standard pressures. The offset is the new value of PA, the slope is the new value of PM. If the RPM4-E-DWT was AutoZeroed properly to calibration, HEAD was set to zero and the pressures from the calibration reference were properly adjusted to the RPM4-E-DWT reference level (TEST port), the value of PA should be very close to zero.

9 Press [SPECIAL], <8Cal>, <1Hi Q-RPT > or <2Lo Q-RPT >, <2edit> and write the new calibration date and the new values of PA and PM for the Q-RPT calibrated (see Section 5.3.6).

10 Calculate as left data for the calibration if desired following:

as left reading = non-corrected reading • new PM [Note: PA should be 0]

11 Perform additional verification pressure runs as desired.

5.4 E-DWT MAINTENANCE

There are no E-DWT maintenance procedures other than the overhaul procedure.

5.4.1 E-DWT OVERHAUL

E-DWT-10000-AF is generally overhauled as one common assembly. Removal of RPM4-E-DWT from the E-DWT is not recommended unless required to perform RPM4-E-DWT and/or E-DWT repairs. See Section 5.5.1 if it is necessary to remove the RPM4-E-DWT from the E-DWT.

Any or all of the following items may be included as part of an E-DWT-10000-AF overhaul:

- Check that RPM4-E-DWT rear panel mounted cooling fan operates when RPM4-E-DWT is powered.
- Clean and inspect E-DWT TEST port connection.
- Purge and clean reservoir and internal hydraulic circuit. Replace used oil with clean oil.
- Check that internal fittings, screws, bolts and nuts are tight.
- Perform system leak and operational check.
- Check Lo Q-RPT pressure relief valve for proper operation. It should crack at about 1 500 psi. Do not apply pressure greater than 1 500 psi to the RPM4-E-DWT Lo Q-RPT as it may be damaged beyond repair. The RPM4-E-DWT warranty does not cover damage due to Q-RPT overpressure.
- Clean RPM4-E-DWT and E-DWT front panel.
- Verify that RPM4-E-DWT internal barometer reads atmospheric pressure within ± 0.15 psi (1 kPa). Adjust if necessary (See Section 5.2.2).

- Perform calibration of quartz reference pressure transducers (Q-RPTs), if necessary (see Section 5.2.2)

5.5 E-DWT REPAIR

5.5.1 REMOVING RPM4-E-DWT FROM THE E-DWT

 The E-DWT-10000-AF is an integrated assembly. The RPM4-E-DWT should not be removed from the E-DWT unless it is necessary for RPM4-E-DWT and/or E-DWT repairs. The RPM4-E-DWT should be calibrated in the E-DWT mounting system as the RPM4-E-DWT orientation may affect its calibration.

To remove the RPM4-E-DWT A70M/A7M-AF from the E-DWT, proceed as follows:

- 1 Vent pressure from the RPM4-E-DWT.
Close the reservoir cap and reservoir vent valve. Do not overtighten cap, do not go CW past CLOSE position.
Plug the test port and close the reservoir shutoff valve.
 - 2 Place the E-DWT-10000-AF on its left side and remove two of the variable volume handles to allow the E-DWT-10000-AF to lay flat on its side.
 - 3 Remove the screws from the perimeter of the side panel using a 2 mm Allen head wrench. Lift to remove panel.
 - 4 Remove the J1 ACC circular connector (LED assembly) and 12 VDC power cable from the rear panel.
 - 5 Using a 7 mm wrench, remove the nuts and lock washers from the front of the RPM4-E-DWT side rack mount bracket. Then remove the nuts, washers, and lock washers from both ends of the rear rack mount bracket.
 - 6 Using a 3 mm Allen head wrench, remove the M3 screws from the rear of the RPM4-E-DWT rack mount bracket on both the right and left sides.
-

 Do not remove the M3 screws from the lower right side of the rack mount kit as this will detach the Variable Volume mounting bracket.

- 7 With the rear rack mount bracket loose, gently pivot it down and away from the RPM4-E-DWT side rack mount bracket, and then remove the side rack mount bracket.
- 8 Remove the HIGH and LOW RPT pressure connections from the rear of the RPM4-E-DWT with a 7/16 inch and 1/2 inch wrench. Do not remove the NPT thread adaptors from the Q-RPT TEST(+) ports. Then gently pull back on the stainless steel tubes to disengage from the adaptors.
- 9 The RPM4-E-DWT is now cleared for removal. Take care not to drag the RPM4-E-DWT front panel across the two metal studs on the inside of the housing.
- 10 To reassemble, reverse the procedure. When reassembling the high pressure gland and collar fittings, protect the conical tip from damage and be sure that the collar is fully threaded on the nipple (left hand thread) before tightening the gland nut. Leak check all connections after reassembly.

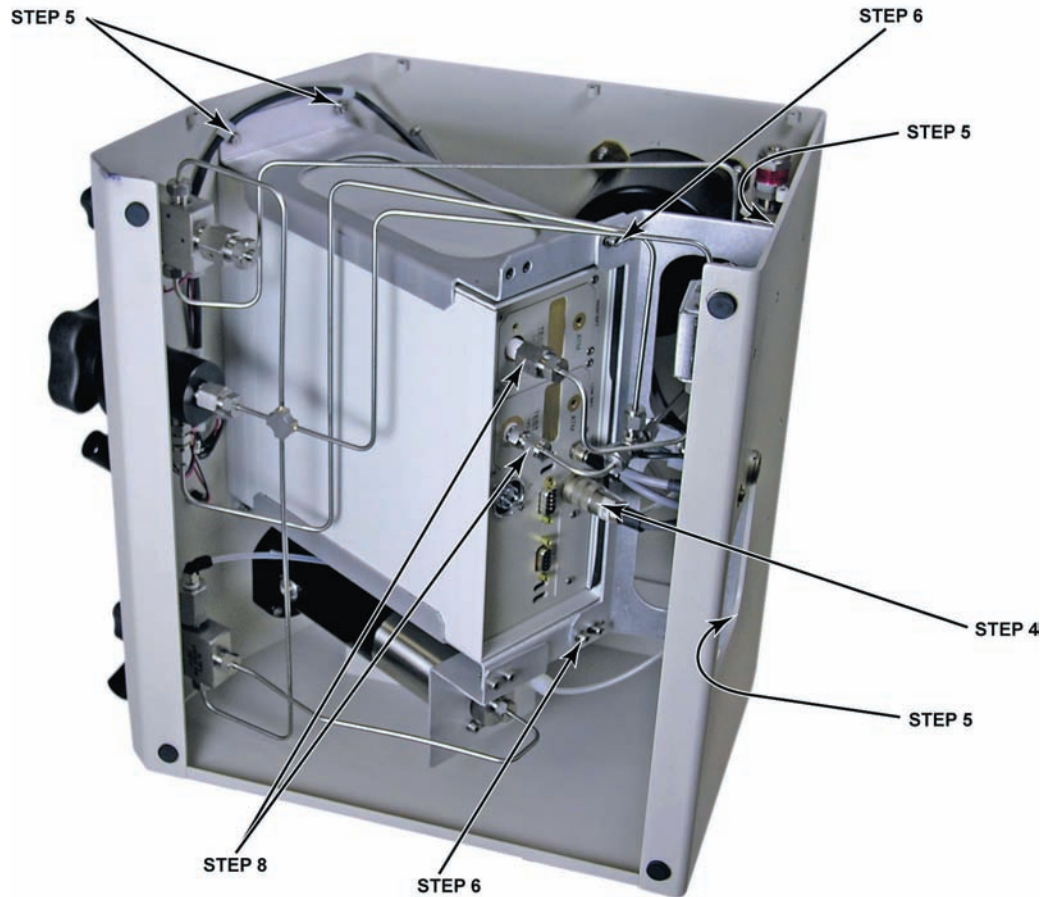

Figure 13. RPM4-E-DWT removal from E-DWT

5.5.2 OPENING AND CLOSING THE RPM4-E-DWT ENCLOSURE

To open the RPM4-E-DWT case, first remove the RPM4-E-DWT from the E-DWT (see Section 5.5.1). Once the RPM4-E-DWT is removed from the E-DWT, proceed as follows:

- ❶ Place the RPM4-E-DWT bottom side up on a stable, flat surface.
- ❷ Remove the four (4) Phillips head screws at the four corners of the RPM4-E-DWT bottom panel.
- ❸ While holding the bottom panel and cover together, turn the RPM4-E-DWT over and place it bottom side down.
- ❹ Lift the top cover off of the bottom panel leaving the front and rear panels behind with the bottom panel. The front and rear panel fit into guide slots on the top cover.
- ❺ To reassemble, reverse the procedure. Before putting the cover on, check that the front is well seated in its guide slots on the bottom panel.

5.5.3 RELOADING EMBEDDED SOFTWARE INTO RPM4-E-DWT FLASH MEMORY

RPM4-E-DWT uses FLASH memory. This allows the embedded software that controls RPM4-E-DWT operations and functions to be loaded into RPM4-E-DWT over its COM1 port from a computer with a simple FLASH loading utility program.

To replace corrupted software or upgrade your software, access the **DHI** web site at **www.dhstruments.com** and go to **SOFTWARE**. A FLASH loading utility and the latest RPM4-E-DWT software are available for download at no charge. If you do not have access to the web or have difficulty downloading or loading software, contact your **DHI** representative or a **DHI** Authorized Service Provider (see Table 25) for assistance.

If you believe you have discovered an error or “bug” in RPM4-E-DWT software, please report it with complete details by email to **cal.repair@dhstruments.com**.

 The DHI flash software loading utility and RPM4-E-DWT embedded software are available for download from www.dhstruments.com in the **SOFTWARE** section.

5.5.4 REPLACING THE E-DWT HIGH PRESSURE RUPTURE DISK

The E-DWT-10000-AF has a rupture disk to protect against serious damage to the high pressure (A70M) Q-RPT due to overpressure. The maximum pressure of the A70M is 10 000 psi (70 MPa). The rupture disk is designed to rupture at 11 500 psi (79.3 MPa). Prior to reaching this pressure, a high-pitched audible alarm will sound indicating that PMAX has been exceeded.

A spare rupture disk is not provided with the E-DWT-10000-AF system. If a replacement disk is required, it will need to be procured from the manufacturer.

Manufacturer: High Pressure Equipment Co. (“HiP”)
Part number: RD11500
www.highpressure.com
1-800-289-7447

Procedure, to replace the rupture disk:

- ❶ Vent pressure from the RPM4-E-DWT.
Close the reservoir cap and reservoir vent valve. Do not overtighten cap, do not go CW past CLOSE position.
Plug the test port and close the reservoir shutoff valve.
- ❷ Place the E-DWT-10000-AF on it’s right hand side.
- ❸ Remove the screws from the perimeter of the left side panel using a 2 mm Allen head wrench. Lift to remove panel.
- ❹ Remove the 1/8 inch O.D. PFA tubing from the quick connect tube fitting by pressing in on the collar of the fitting and pulling back on the tube.

 Prepare to catch oil runoff from the tube with a small cup and/or towel. Any oil that is in the clear PFA tube going back to the Reservoir Shut Off valve will spill out.

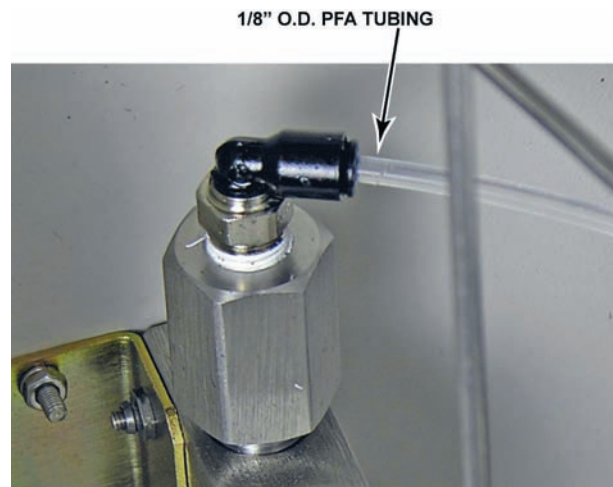

Step 4

- ⑤ Loosen and back out the high pressure gland from the top side of the safety tee using a ½ inch wrench.

Loosen and back out the high pressure gland from the bottom side of the safety tee.

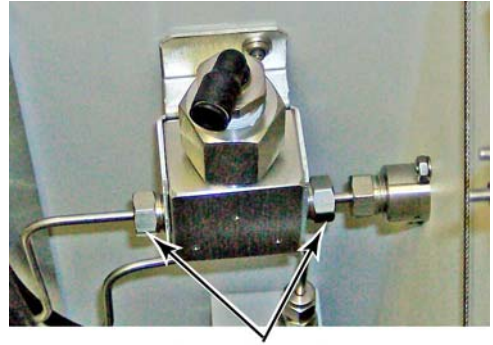

HIGH PRESSURE GLAND

Step 5

- ⑥ Remove the mounting bracket from the E-DWT enclosure by backing out the two Philips head (“+” style) screws from the outside rear of the enclosure. Once removed, the safety tee is now free to move.
- ⑦ Gently pull back on the high pressure stainless steel tube to remove it from the safety tee. Then remove the safety tee from the tube connector on the top side. The tee assembly is now free to be disassembled on a workbench.

 *Be careful not to scrape or damage the coned tube tip as this is where the high pressure seal is made. A damaged tip can result in fluid leaks.*

 *To help ease the reassembly process, remove the other end of the short nipple from the bottom side of the TEST fitting bulkhead. (The nipple will be reassembled with the bracket and tee before being assembled back into the E-DWT.)*

- ⑧ Remove the safety head from the safety tee using a pair of 1 inch wrenches. Do not remove the ¾ inch pipe to quick connect adaptor.
- ⑨ Replace the ruptured disk with a new replacement. (HiP p/n: RD11500)
- ⑩ Reassemble per the drawing. It is important the new rupture disk is correctly orientated or it may deform under reassembly and fail. Torque the safety head to 102 Nm (75 ft*lb)

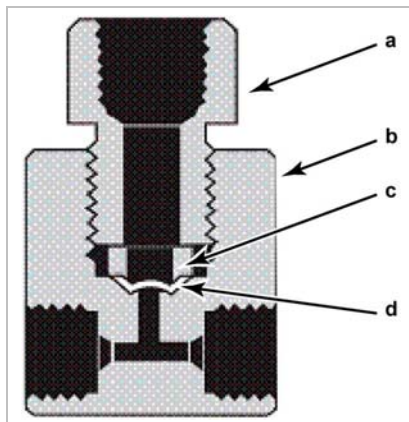

- a. Safety head
 b. Safety tee
 c. Positioning collar – bevel faces down towards the rupture disk, flat side towards the safety head.
 d. Rupture disk

- ⑪ Prior to reinstalling the safety tee assembly back into the E-DWT housing, first insert the gland and collar nipple assembly into the top side of the tee and tighten to a torque of 8.5 Nm (75 inch*lb).



Step 11

- ⑫ To reassemble, reverse the procedure. When reassembling the high pressure gland and collar fittings, protect the conical tip from damage and be sure that the collar is fully threaded on the nipple (left hand thread) before tightening the gland nut. Leak check all connections after reassembly.
- ⑬ Finish by filling and priming the lines with oil per section 3.5.1.

5.5.5 RPM4-E-DWT SUBASSEMBLY DESCRIPTION AND LOCATION

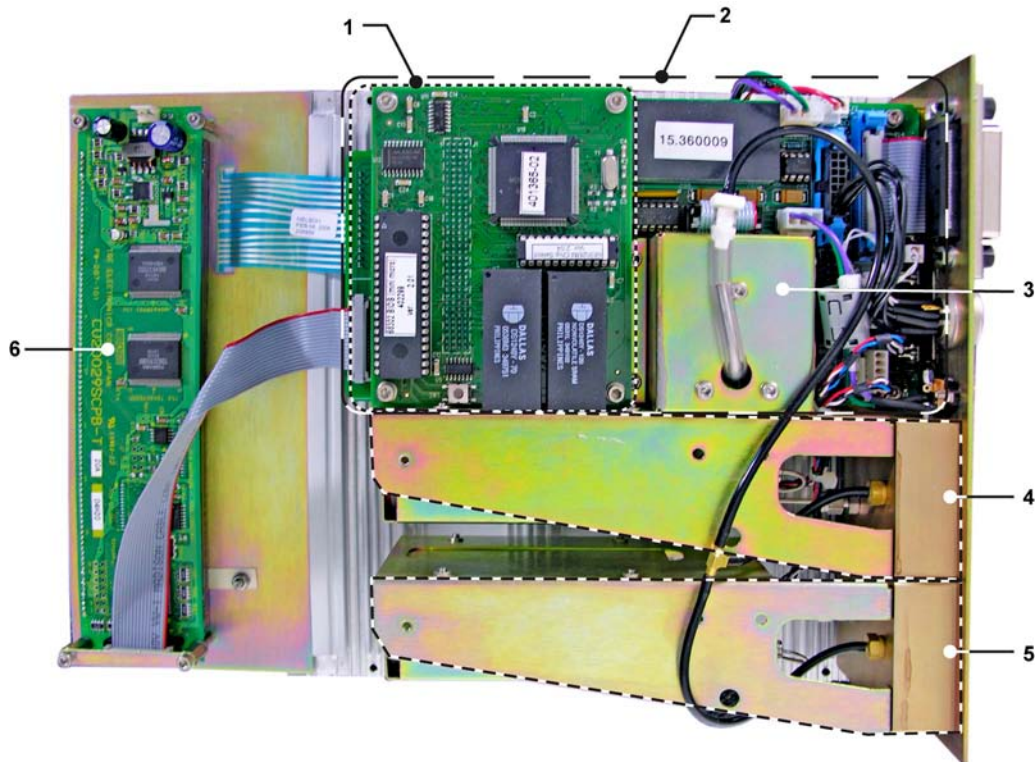

- | | | |
|-----------------|--------------------------|---------------------------|
| 1. Micro card | 3. On-Board Barometer | 5. Hi Q-RPT module (A70M) |
| 2. Driver Board | 4. Lo Q-RPT module (A7M) | 6. Display |

Figure 14. RPM4-E-DWT internal view

5.5.5.1 MICRO BOARD

The micro board supports a Motorola 68302 micro-controller, EPROM, EEPROM, 128k x 16 bit NVRAM, 8 Mbit flash memory; RS-232 and IEEE-488.2 communications; keypad and display control. An I/O port controls other ports and devices in RPM4-E-DWT.

5.5.5.2 DRIVER BOARD

The driver board is controlled by the micro board (see Section 5.5.5.1). It supports:

- **Frequency counters (2) for reading Q-RPTs (see Section 5.5.5.4)**
- **On-board barometer power and output (see Section 5.5.5.3)**
- **Power to the system cooling fan**
- **Remote [ENT]**
- **Keypad and display**
- **Beeper**

5.5.5.3 ON-BOARD BAROMETER

The on-board barometer supports a board mounted, barometric range, micro machined silicon sensor and an ambient temperature sensor. The barometer readings are used for dynamic atmospheric pressure compensation when measuring gauge pressure with an absolute quartz reference pressure transducer (see Section 3.9.1). The temperature sensor is used for temperature compensation of the barometric sensor.

5.5.5.4 Q-RPT MODULE

The Q-RPT module is an integrated Quartz Reference Pressure Transducer (Q-RPT) assembly. The module includes a Q-RPT, brackets to hold the transducer, interconnecting tubing and a manifold with **TEST(+)** and **ATM** ports.

A Q-RPT provides very high precision, low uncertainty pressure measurement. The basic sensing principle is the measurement of the change in the natural oscillating frequency of a quartz tuning fork in response to changes in temperature and mechanical stress resulting from the change in pressure applied to a connecting bellows or bourdon tube. Two independent quartz elements are used. One quartz element is subjected to pressure related stress. The other quartz element is used only to monitor temperature. See Section 1.2.3.1 for Q-RPT specifications.

See Section 5.5.6, Figure 15 for a pneumatic schematic of the Q-RPT module configuration.

HI Q-RPT MODULE

The RPM4-E-DWT A70M/A7M-AF Hi Q-RPT is an A70M. The A70M has a pressure range of atmosphere to 10 000 psi (70 MPa) gauge.

LO Q-RPT MODULE

The RPM4-E-DWT A70M/A7M-AF Lo Q-RPT is an A7M. The A7M has a pressure range of atmosphere to 1 000 psi (7 MPa) gauge.

5.5.5.5 DISPLAY

2 x 20 character vacuum fluorescent display.

5.5.5.6 COOLING FAN

The cooling fan is mounted on the RPM4-E-DWT rear panel and connected to the main board. It is a 12V brushless DC fan.

5.5.6 HYDRAULIC SCHEMATIC OF Q-RPT MODULE

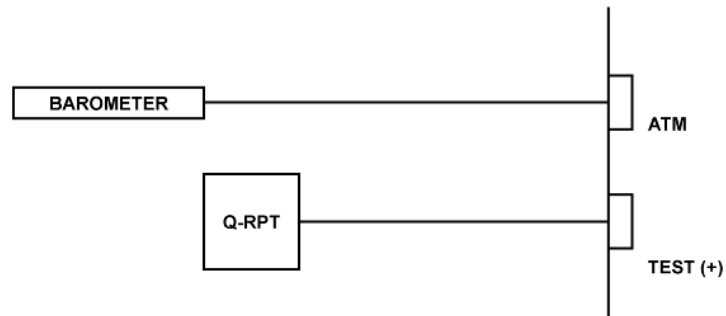

Figure 15. Hydraulic schematic RPM4-E-DWT Q-RPT Module

5.6 ILLUSTRATED PARTS BREAKDOWN

5.6.1 E-DWT-10000-AF ILLUSTRATED PARTS BREAKDOWN

Table 16. E-DWT exterior illustrated parts breakdown (see Figure 16)

# REQUIRED	DESCRIPTION	PART NO.
1	E-DWT-10000-AF	3322392
1	DH500 bulkhead	3150589
1	DH500 plug	3068470
1	DH500 gland	3068419
2	Screw, M4 x 10	3153285
2	Nut	3153914
2	Lock washer	3153147
1	Priming pump assembly	3338698
1	Vent assembly	3338705
1	Reservoir lid	3327974
1	Right side panel	3329385
2	Handle	3308993
1	RPM4-E-DWT A70M/A7M-AF	3337317
14	Screw, M3 x 6	3154677
2	Knob, modified	3337089
2	Shut off valve	3328687
1	Range selection valve	3337092
1	Enclosure	3330551
1	Variable Volume assembly	3337077
1	Left side panel	3329397
4	Handle, VV	3329907
1	Shut off valve	3328687

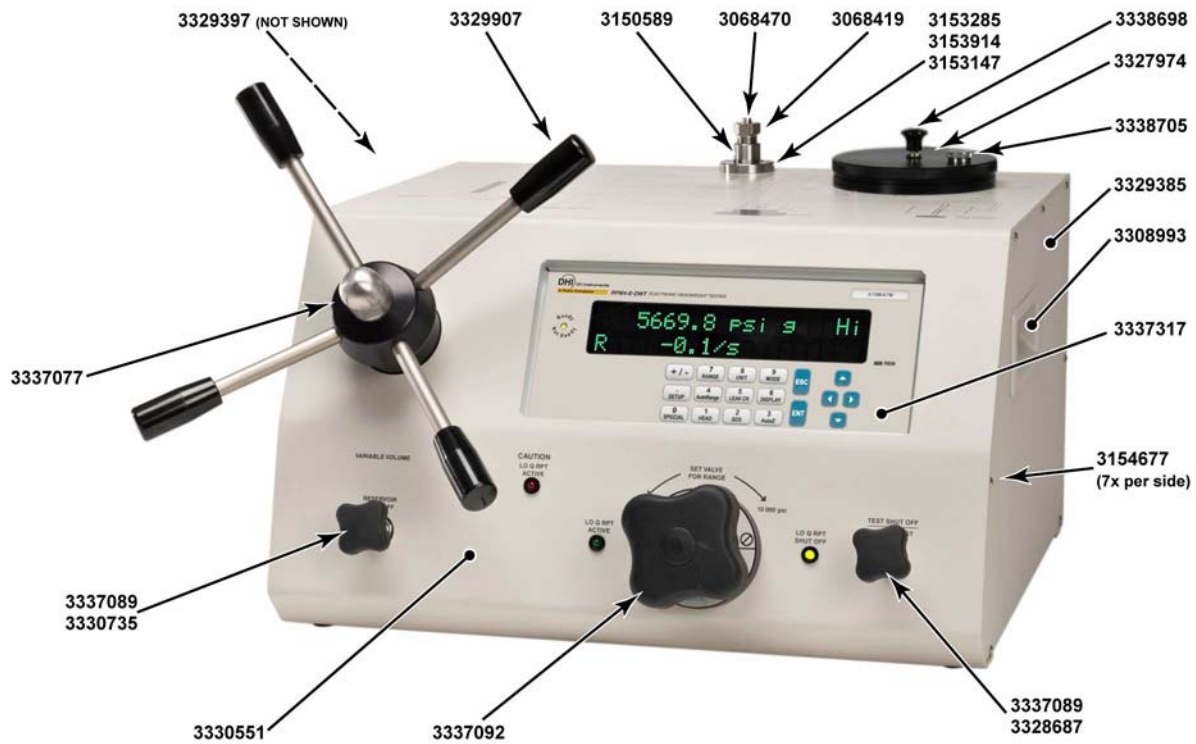

Figure 16. E-DWT exterior view

Table 17. E-DWT internal illustrated parts breakdown (see Figure 17)

# REQUIRED	DESCRIPTION	PART NO.
4	Rubber foot pad	3154424
2	Rack mount bracket, side	3329131
4	Screw, M4 x 12	3153224
1	Cable, DC power	3335962
1	Cable, LED assembly	3122849
1	Rack mount bracket, rear support	3329122
1	VV mounting bracket	3329073
4	Screw, M4 x 12	3153285
12	Washer, M4	3153079
6	Lock washer, M4	3153914
6	Nut, M4	3153147
1	Variable Volume assembly	3337077
16	Nut, M3	2678004
14	Lock washer, M3	3153752
1	Indicator backplate	3329064
1	VV position indicator	3331669
1	Indicator tube	3331657
1	Indicator cable	3331640
2	Cable guide pulley	3330322
1	Spring	3330712

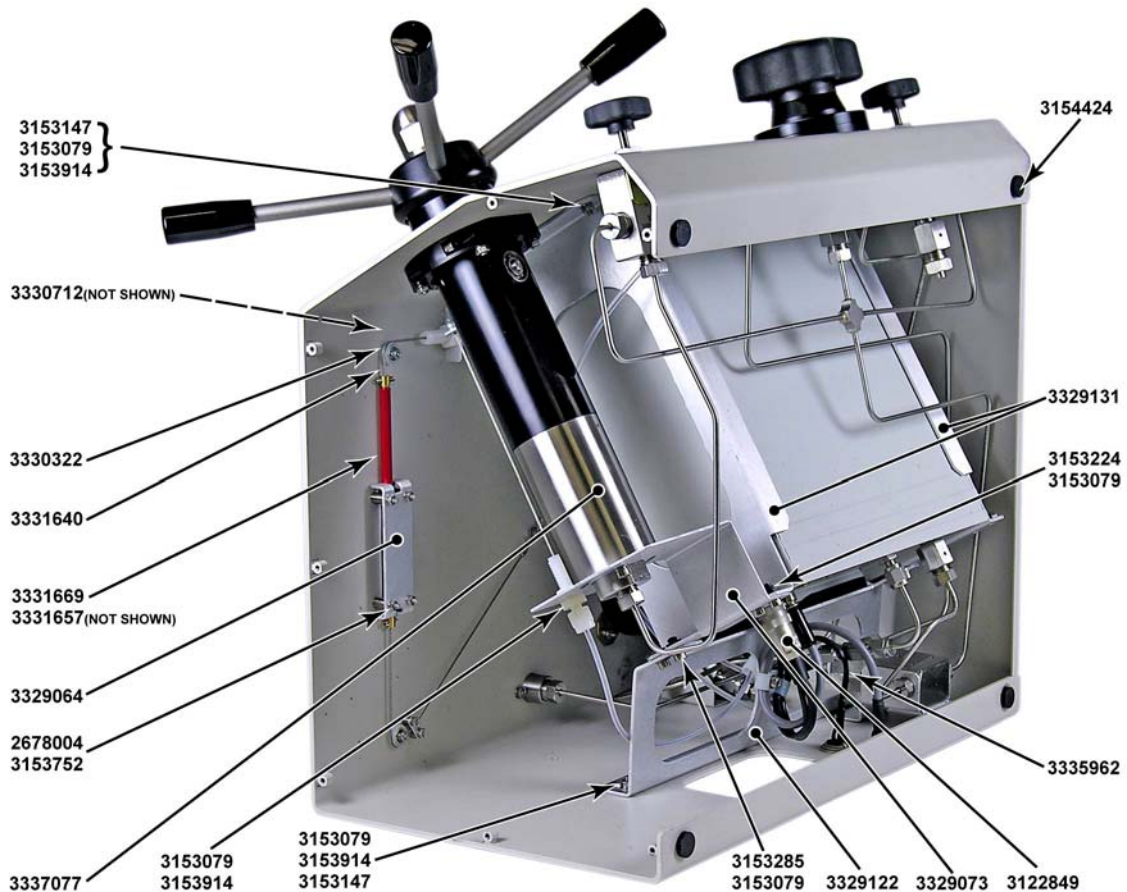

Figure 17. E-DWT internal view

5.6.2 E-DWT-10000-AF DETAILED HYDRAULIC SCHEMATIC

Table 18. E-DWT-10000-AF, detailed hydraulic schematic illustrated parts breakdown (see Figure 18)

# REQUIRED	DESCRIPTION	PART NO.
1	DH500 plug	3068470
1	DH500 gland	3068419
1	DH500 bulkhead	3150589
12	High pressure gland	3143178
12	High pressure collar	3143184
2	Tee, nylon	3143366
1	Safety tee with Safety head	3330814
1	Rupture disk	3330463
1	Tube weld	3337407
1	Adaptor, high pressure	3330799
1	Adaptor	3068564
1	RPM4-E-DWT	3337317
2	Valve, shut off	3328687
2	Knob, valve	3337089
1	Tube nipple	3337185
1	Manual valve	3337092
1	Adaptor	3119717
1	Adaptor	3330892
1	Elbow adaptor	3141502
4	PFA tubing	3232357
1	Tube weld	3337149
1	Variable Volume	3337077
1	Elbow adaptor	3141147
1	Priming pump assembly	3338698
1	Pump reservoir assembly	3337108
1	Pressure relief valve	3138306
1	Relief spring	3330701
1	Adaptor	3135767
1	Tee	3133091
3	SS tubing	3331990
1	Elbow adaptor	3330694

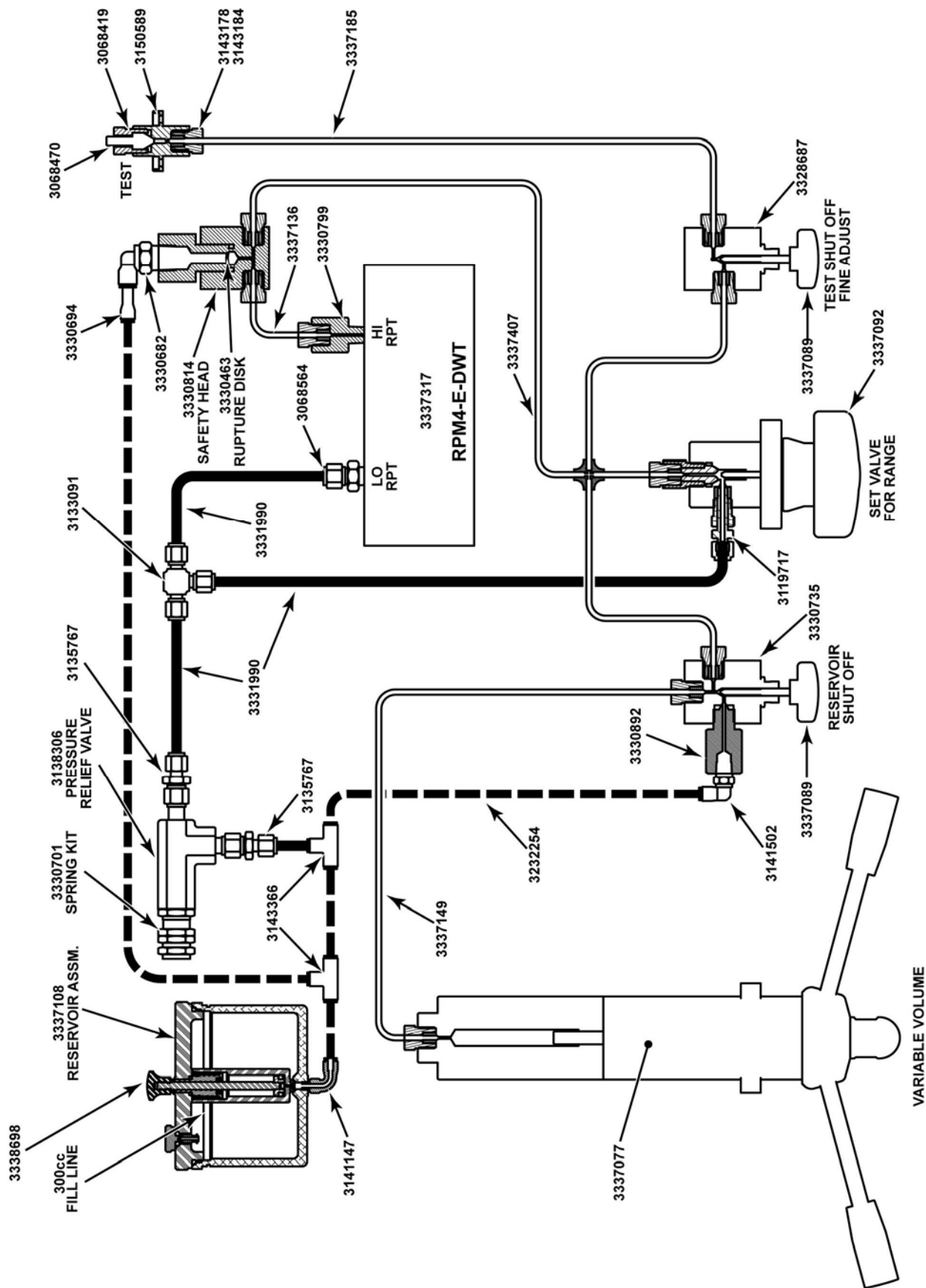

Figure 18. E-DWT detailed hydraulic schematic

5.6.3 RPM4-E-DWT A70M/A7M-AF ILLUSTRATED PARTS BREAKDOWN

Table 19. RPM4-E-DWT rear panel, external view illustrated parts breakdown (see Figure 19)

# REQUIRED	DESCRIPTION	PART NO.
1	DC Power jack	1765470
1	J1 ACC connector	3122919
1	Cover plate	3331706
1	Rear panel	3329105
1	Fan 12V	3140519
2	Screw, M2.5	3154307
1	Adaptor, low	3068564
8	Screw, M3	3153199
1	Adaptor, high	3330799

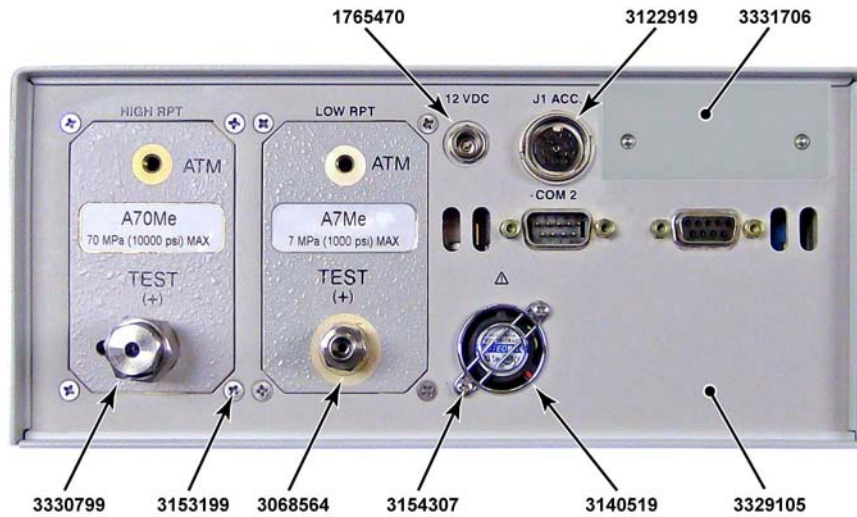

Figure 19. RPM4-E-DWT rear panel, external view illustrated parts breakdown

Table 20. RPM4-E-DWT Q-RPT assembly, internal view illustrated parts breakdown (see Figure 20)

# REQUIRED	DESCRIPTION	PART NO.
1	Manifold, A7M-AF	3148653
1	Plug, ss	3151095
1	Manifold, A70M	3151088
14	Screw, M3	3154248
14	Lock washer, M3	3153752
2	Adaptor, barb	3137843
4	O-ring, 5-193	3136506
2	Union	3146069
2	Cowling, transducer	3148597
2	Transducer	3081679
2	Bracket, transducer	3148971
1	Tee	3135800

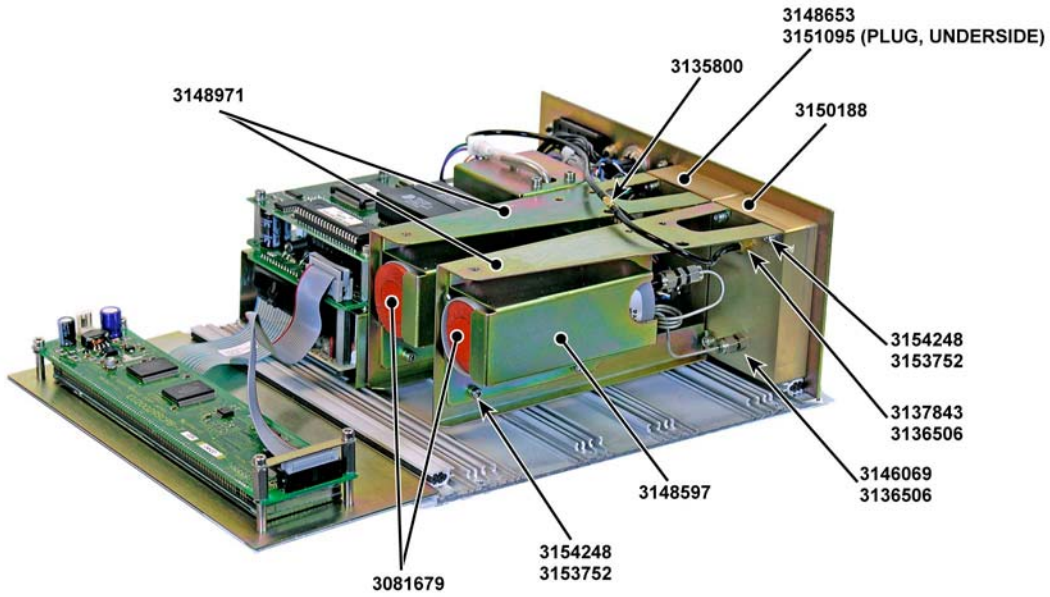

Figure 20. RPM4-E-DWT Q-RPT assembly, internal view illustrated parts breakdown

Table 21. RPM4-E-DWT overall, interior view illustrated parts breakdown (see Figure 21)

# REQUIRED	DESCRIPTION	PART NO.
1	Tubing, vinyl	3232608
1	Adaptor	3140570
1	Micro board	3156058
1	Electronic chassis	3148892
5	Nut	3149280
12	Lock washer, M3	3153752
5	Screw, M3	3152908
1	Tubing, polyurethane	3232477
1	Cable assembly, barometer	3151822
1	Ferrite sleeve	3136523
7	Screw, M3	3154248
1	Bracket, barometer	3148814
1	Barometer assembly	3126355

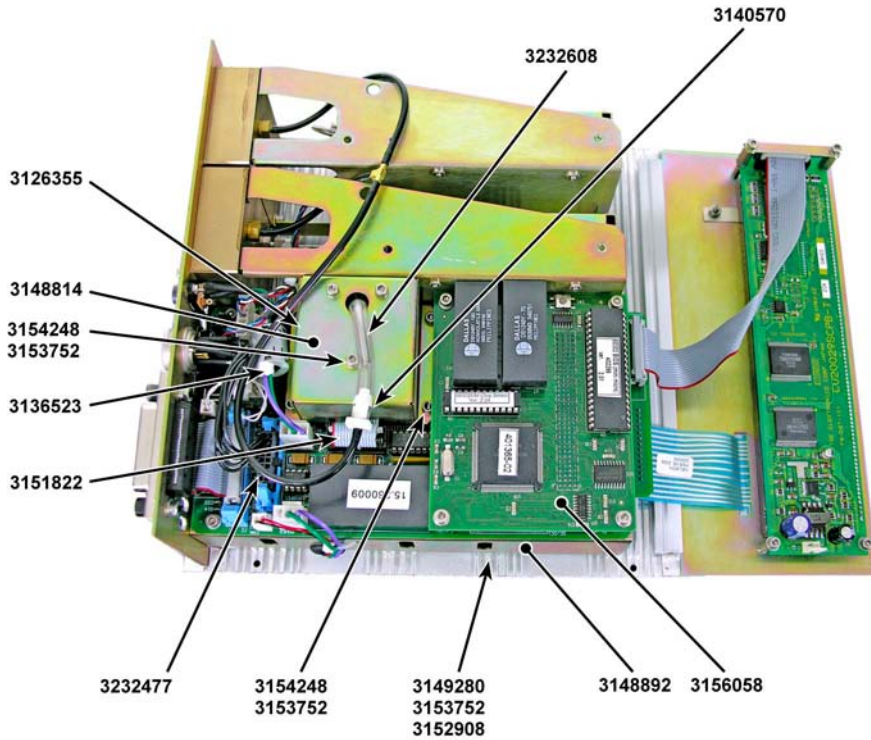

Figure 21. RPM4-E-DWT overall, interior view illustrated parts breakdown

Table 22. RPM4-E-DWT display assembly, interior view illustrated parts breakdown (see Figure 22)

# REQUIRED	DESCRIPTION	PART NO.
1	Ribbon cable	3151805
5	Lock washer	3153752
1	Nut, M3	2678004
2	Standoff, M3	3137784
4	Screw, M3	3154248
9	Washer	3152972
1	Retainer plate	3148915
1	Display assembly	3139814
1	Panel, front	3148903

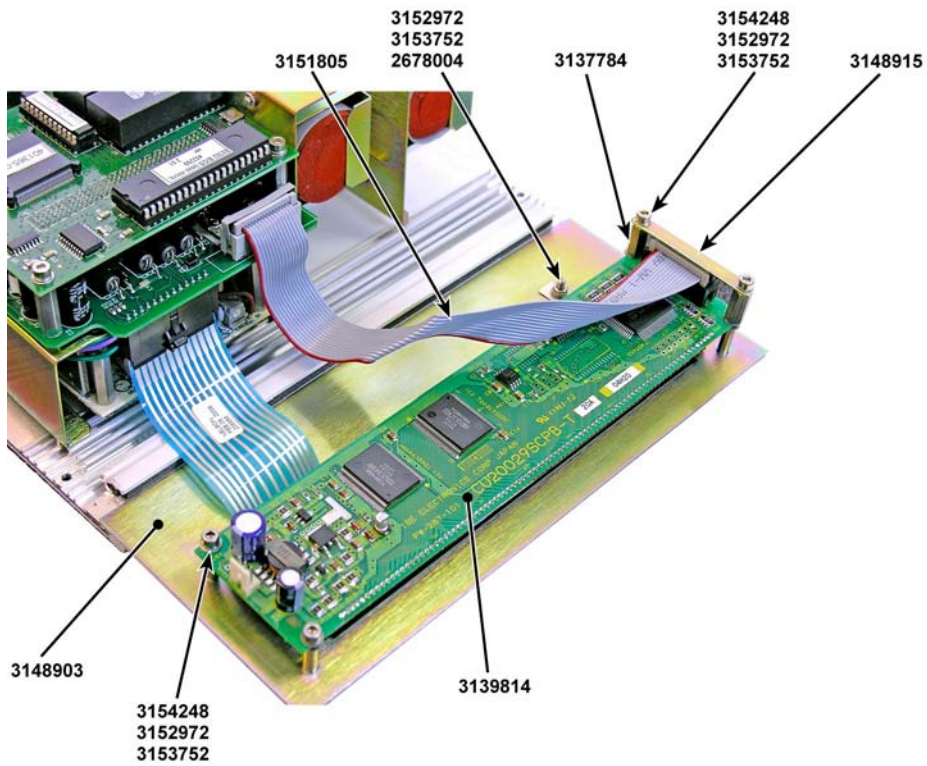

Figure 22. RPM4-E-DWT display assembly, interior view illustrated parts breakdown



6. TROUBLESHOOTING

RPM4-E-DWT is a sophisticated pressure setting and measuring instrument with advanced on-board features and functions. Before assuming that unexpected behavior is caused by a system defect or breakdown, the operator should use this manual and other training facilities to become thoroughly familiar with RPM4-E-DWT operation. This troubleshooting guide is intended as an aid in identifying the reason for RPM4-E-DWT behavior and determining whether the behavior is normal operation or due to an internal or external problem.

Identify the symptom or unexpected behavior you are observing from the **SYMPTOM** list below. A **PROBABLE CAUSE** is provided and a **SOLUTION** is proposed including references to manual sections that provide information that may be of assistance.

Table 23. Troubleshooting guide

SYMPTOM	PROBABLE CAUSE	SOLUTION
Cannot access certain functions > ACCESS RESTRICTED <	User level has been set that restricts access to certain functions.	Change user level or consult system manager. 3.9.5.5
Displays < FATAL ERROR > or < FATAL FAULT >.	Encountered unresolved internal software conflict.	Cycle power to clear. Please record conditions leading up to event including the numbers displayed when [ENT] is pressed and report to your DHI Authorized Service Provider. Table 25
Front panel keys seem to be disabled.	"remote" command has been sent from a host computer.	Send "local" command from host computer or cycle RPM4-E-DWT power. 4, 4.4.4
Measured pressure display or other displays have too much/not enough resolution.	Resolution setting needs to be changed.	Change resolution setting using the resolution function, using AutoRange or by initializing an AutoTest. 3.8.2, 3.7.5, 3.7.11
Can't increase resolution to level desired in AutoRanged range.	Resolution setting is limited when AutoRanging under 10 % of Q-RPT default range.	Operation is normal. 3.7.5, Table 4
Values that should be non-zero are displayed as zero.	Resolution setting needs to be increased to view significant digits.	Change resolution setting. 3.8.2
Keypad presses make undesired sounds or NO sounds.	Keypad sound settings are incorrect.	Use SOUND function to set keypad sounds as desired. 3.9.5.2
Bottom line of display has changed and you want to change it back.	The DISPLAY function has been used to change the display.	Use [DISPLAY] to set bottom line to desired display. 3.7.7
Bottom line of display is blank.	DISPLAY mode is "clean".	Use [DISPLAY] to change bottom line display if desired. 3.7.7
The pressure units available under the [UNIT] function key are not those desired.	UNIT function needs to be customized.	Use Punit function to customize the UNIT function or reset units to default. 3.9.6, 3.9.9.2
Front panel display is dim.	Screen saver option has activated.	Operation is normal. Press any key to resume full screen power. Adjust screen saver time, if desired. 3.9.5.1
AutoRange is not selecting the desired Q-RPT for the specified range.	The Q-RPT range does not cover the specified AutoRange full scale pressure.	Check that Q-RPT default range is high enough to cover the AutoRange. 1.2.3.1
Pressure display is flashing and beeper is sounding intermittently.	Current upper limit of active range has been exceeded.	Reduce pressure. Change UL and/or change active range using [RANGE], [AUTORANGE] or AutoTest. 3.8.4, 3.7.5, 3.7.11

SYMPTOM	PROBABLE CAUSE	SOLUTION
"Hi (or Lo) Q-RPT EXCEEDED PMAX" displays alternating with normal display.	RPM4-E-DWT Q-RPT has been overpressured (Pmax! exceeded).	Correct the overpressure condition and cycle power ON and OFF to clear. Q-RPT may be damaged. 3.8.4.1
Display is <!!!!LO RPT ACTIVE!!!!> the E-DWT CAUTION LO RPT ACTIVE light is flashing and RPM4-E-DWT is beeping.	The Lo Q-RPT is receiving pressure but the Hi Q-RPT is currently selected.	Since the Hi Q-RPT is selected on RPM4-E-DWT, the Lo Q-RPT should be shut off by the Lo Q-RPT shut off valve. Reduce pressure and close the Lo Q-RPT shut off valve or select the Lo Q-RPT on the RPM4-E-DWT. Do not apply more than 1 000 psi (7 MPa) to the Lo Q-RPT. 3.4
A Ready (green Ready/Not Ready indicator) indication is never achieved.	Stability settings is too tight and/or existing conditions will not allow Ready to be achieved.	Adjust stability setting or correct other conditions. Consider using an AutoTest to set stability appropriately. 3.8.3, 3.1.2, 3.7.11
Display update rate of indicated pressure changes when changing pressure.	RPM4-E-DWT automated read rate function is ON to automatically adjust read rate depending upon rate of change of pressure.	Operation is normal. Turn automated read rate function OFF if desired. 3.9.7.2
Display update of indicated pressure is too slow when pressure is changing quickly.	RPM4-E-DWT automated read rate function is OFF.	Turn automated read rate function ON to automatically adjust read rate depending on pressure rate of change. 3.9.7.2
Pressure is changing but display of pressure is NOT and the bottom right hand corner of the display is a numerical countdown followed by <avg>.	Average DISPLAY function is ON and pressure display is updating only with the average value at the end of each averaging cycle.	Go to a DISPLAY function other than average or press [+/-] to get the instantaneous value Average DISPLAY. 3.7.7, 3.7.7.1
Pressure indicated by RPM4-E-DWT never becomes stable.	These is a leak in the pressure system to which E-DWT is connected.	Find and correct leak. Consider using RPM4-E-DWT leak check function. 3.7.6
	The pressure applied to the RPM4-E-DWT has recently been changed and the pressure is still stabilizing.	The time it takes for pressure to stabilize after making a pressure change increases with the size of the pressure change and size of the test volume. Up to three minutes or more can be required for pressure to stabilize within 0.01% of the measured pressure
	The RPM4-E-DWT display resolution is higher than is necessary and you are observing normal evolution of the pressure (Note: if viewed with enough resolution, pressure is NEVER perfectly stable).	Use the resolution setting function, AutoRange or AutoTest to reduce resolution to a level that is appropriate for the test being run or the uncertainty of the device being calibrated. 3.8.2, 3.7.5, 3.7.11
Disagreement between two Q-RPTs in system appears excessive.	Difference is actually within tolerance and acceptable disagreement.	Compare differences observed to tolerances on Q-RPT measurements. 1.2.3.1
Apparent inaccurate pressure control/measure and little or no response from Q-RPT:	Reference transducer destroyed by overpressure.	Contact DHI Authorized Service Provider. Table 25
Apparent inaccurate pressure measurement.	Incorrect pressure units.	Set desired pressure. Consider reference temperature if unit is inWa. 3.7.3
	Q-RPT calibration coefficients have been altered.	Check and correct calibration coefficients if needed. 5.2.2
	RPM4-E-DWT has not been AutoZeroed or had been AutoZeroed incorrectly.	Run AutoZ correctly. 3.9.1
Apparent inaccurate pressure measurement and <h> is displayed on top line of screen.	An unplanned "head" correction is active or head height or fluid is incorrect.	Operation is normal. Remove or change "head" correction. 3.7.8
AutoZ was just run but measurement indication is NOT zero. <h> is displayed on top line of screen.	A head correction is applied and current indication is the value of the head.	Operation is normal. 3.7.8, 3.9.1

SYMPTOM	PROBABLE CAUSE	SOLUTION
Pressure applied is zero gauge but reading is NOT zero.	Need to run AutoZ to rezero in gauge mode.	Run AutoZ. 3.7.10
	Reservoir shut off and or TEST shut off valve are not open so back pressure is trapped in E-DWT or in TEST system.	Open reservoir shut off and TEST shut off valves. 3.5
	Reservoir cap vent valve is closed so reservoir is not open to atmosphere.	Open reservoir cap vent valve. 3.5
Is NOT reading pressure applied to the Lo Q-RPT.	E-DWT Lo Q-RPT Shut Off Valve is closed shutting off the Lo Q-RPT from the E-DWT TEST port.	Familiarize yourself with the E-DWT schematic and operation. Open the Lo Q-RPT Shut Off Valve. 3.4
Is NOT reading pressure applied to RPM4-E-DWT TEST port.	TEST shut off valve is closed.	Familiarize yourself with your E-DWT schematic. Open TEST shut off valve. 3.5
Cannot generate pressure with variable volume.	TEST shut off valve is closed.	Familiarize yourself with your E-DWT schematic. You are generating pressure but are not connected to the TEST port. Open TEST shut off valve. 3.5
	Reservoir shut off valve is open.	Familiarize yourself with your E-DWT schematic. Close reservoir shut off valve. 3.5
	Too much air in test system to which E-DWT is connected.	The test system must be filled with oil and primed before pressure can be generated. Fill and prime the test system. 3.5
	Reservoir empty. No oil in variable volume.	Fill reservoir. 3.5
	High pressure system rupture disk failed.	Replace rupture disk. 5.5.4
It takes too long to generate the first pressure. Need to refill the variable volume multiple times.	Too much air in test system to which E-DWT is connected or test volume too large.	The test system must be filled with oil and primed before pressure can be generated. Fill and prime the test system before starting the test. If the test volume is too large, consider prefilling with external means. 3.5
Priming pump will not generate pressure.	Reservoir cap not installed, tip of pump is too far from reservoir seat.	Rotate reservoir cap CW until cap vent valve is at CLOSE indicator (do not overtighten).
	Reservoir empty.	Refill reservoir.
	Reservoir shutoff vavve closed.	Open reservoir shut off valve. 3.5
[ENT] is not accessing the AutoTest function.	You are in a Display mode other than Rate that uses the [ENT] key.	Press [DISPLAY] and set the Display mode to Rate. 3.7.7.2

NOTES



7. APPENDIX

7.1 UNIT CONVERSION

7.1.1 PRESSURE

RPM4-E-DWT performs all internal calculations in SI units. Numerical values input or output in other units are converted to SI immediately after entry and back to other units just before output as needed.

Table 24 provides the conversion coefficients used by RPM4-E-DWT to convert numerical values expressed in SI units to corresponding values expressed in other units.

Table 24. Pressure unit of measure conversion coefficients

TO CONVERT FROM Pa To		MULTIPLY BY
Pa	<i>Pascal</i>	1.0
Mbar	<i>millibar</i>	1.0 E-02
hPa	<i>hecto Pascal</i>	1.0 E-02
kPa	<i>kilo Pascal</i>	1.0 E-03
Bar	<i>Bar</i>	1.0 E-05
mmWa @ 4°C	<i>millimeter of water</i>	1.019716 E-01
mmHg @ 0°C	<i>millimeter of mercury</i>	7.50063 E-03
Psi	<i>pound per square inch</i>	1.450377 E-04
Psf	<i>pound per square foot</i>	1.007206 E-06
inWa @ 4°C	<i>inch of water</i>	4.014649 E-03
inWa @ 20°C	<i>inch of water</i>	4.021732 E-03
inWa @ 60°F	<i>inch of water</i>	4.018429 E-03
inHg @ 0°C	<i>inch of mercury</i>	2.953 E-04
kcm ²	<i>kilogram force per centimeter square</i>	1.019716 E-05
mTorr	<i>milliTorr (micron of mercury)</i>	7.50063
Torr	<i>Torr (millimeter of mercury)</i>	7.50063 E-3
User	<i>User</i>	User defined coefficient

NOTES



8. WARRANTY

8.1 OVERVIEW

Except to the extent limited or otherwise provided herein, **DH Instruments, a Fluke Company** warrants for one year from purchase, each new product sold by it or one of its authorized distributors, only against defects in workmanship and/or materials under normal service and use. Products which have been changed or altered in any manner from their original design, or which are improperly or defectively installed, serviced or used are not covered by this warranty.

DH Instruments and any of its Authorized Service Providers' obligations with respect to this warranty are limited to the repair or replacement of defective products after their inspection and verification of such defects. All products to be considered for repair or replacement are to be returned to **DH Instruments** or its Authorized Service Provider after receiving authorization from **DH Instruments** or its Authorized Service Provider. The purchaser assumes all liability vis a vis third parties in respect of its acts or omissions involving use of the products. In no event shall **DH Instruments** be liable to purchaser for any unforeseeable or indirect damage, it being expressly stated that, for the purpose of this warranty, such indirect damage includes, but is not limited to, loss of production, profits, revenue, or goodwill, even if **DH Instruments** has been advised of the possibility thereof, and regardless of whether such products are used individually or as components in other products.

Items returned to **DHI** under warranty claim but determined to not have a defect covered under warranty or to not have a defect at all are subject to an evaluation and shipping charge as well as applicable repair and/or calibration costs.

The provisions of this warranty and limitation may not be modified in any respect except in writing signed by a duly authorized officer of **DH Instruments**.

The above warranty and the obligations and liability of **DH Instruments** and its Authorized Service Providers exclude any other warranties or liabilities of any kind.

Table 25. DHI Authorized Service Providers

DH INSTRUMENTS, A FLUKE COMPANY AUTHORIZED SERVICE PROVIDERS			
COMPANY	ADDRESS	TELEPHONE, FAX & EMAIL	NORMAL SUPPORT REGION
DH Instruments, a Fluke Company	4765 East Beautiful Lane Phoenix AZ 85044-5318 USA	Tel 602.431.9100 Fax 602.431.9559 cal.repair@dhinstruments.com	Worldwide
Minerva Meettechniek B.V.	Chrysantstraat 1 3812 WX Amersfoort the NETHERLANDS	Tel (+31) 33.46.22.000 Fax (+31) 33.46.22.218 info@minervaipm.com	European Union
Ohte Giken, Inc. Technology Center	258-1, Nakadai Kasumigaura-machi, Niihari-Gun, Ibaraki 300-0133	Tel 81/29.840.9111 Fax 81/29.840.9100 tech@ohtegiken.co.jp	Japan/Asia

NOTES



9. GLOSSARY

Active Q-RPT	The Q-RPT that is currently selected to be displayed on the top line of the RPM4-E-DWT display. Most function selections affect the active Q-RPT.
AutoRange	A function that optimizes RPM4-E-DWT measurement and control for a specific, user defined range of operation.
AutoRanged Range	An RPM4-E-DWT pressure measurement range created using the AutoRange function.
AutoTest or ATest	RPM4-E-DWT on-board automated testing sequences and their results.
AutoZero or AutoZ	A process by which a Q-RPT is zeroed (offset) relative to a standard.
Barometer	RPM4-E-DWT's on-board atmospheric pressure measuring sensor. Also referred to as on-board barometer.
CCW	Counter clockwise.
CW	Clockwise.
Default Range (DF)	A Q-RPT's maximum range that is always available using [RANGE] and cannot be deleted.
Deviation	A DISPLAY function in which the deviation of the current pressure from a target pressure is displayed.
DUT	Device Under Test. The device or devices pneumatically connected to the RPM4-E-DWT TEST(+) port that the RPM4-E-DWT is being used to test or calibrate.
FS	Abbreviation of "full scale". The full scale value is the maximum pressure of a measurement range. Limits and specifications are often expressed as % FS. Also see span.
Gauge Mode	Measurement mode in which the Q-RPT indicates gauge pressure (difference from atmospheric pressure), but only in the positive direction (above atmosphere).
Head	A difference in height between the RPM4-E-DWT reference level and the DUT.
HiLo	A DISPLAY function in which the highest and lowest pressure measurements since reset are recorded and displayed.
Hi Q-RPT	The designation of a single Q-RPT in an RPM4-E-DWT, or, if there are two, the one that has the highest full scale default range. This is the A70M (10 000 psi) in the RPM4-E-DWT A70M/A7M-AF.
E-DWT	Electronic deadweight tester. A pressure calibration system in which the traditional piston-cylinder and mass set of a deadweight tester are replaced with an electronic, transducer based reference pressure monitor (RPM4-E-DWT).
Inactive Q-RPT	In an RPM4-E-DWT with two Q-RPTs, the Q-RPT that is not currently displayed on the top line of the display. The inactive Q-RPT may be displayed on the second line of the RPM4-E-DWT display using the Q-RPT DISPLAY function.
Lo Q-RPT	The designation of a the Q-RPT with the lower full scale default range in RPM4-E-DWTs with two Q-RPTs. This is the A7M (1 000 psi) in the RPM4-E-DWT A70M/A7M-AF.
P_{offset}	The difference between a Q-RPT reading and the AutoZero reference at the time AutoZ is run. Used by the AutoZ function to compensate Q-RPT readings for zero drift over time.
P_{std,0}	AutoZero reference value. Atmospheric pressure (zero gauge) for RPM4-E-DWT A70M/A7M-AF.
PA	Pressure adder, used to offset a Q-RPT or barometer to calibrate it.
PM	Pressure multiplier, used to adjust span of a Q-RPT or barometer to calibrate it.
Pmax!	The maximum pressure limit of a Q-RPT. If the pressure measured by the Q-RPT exceeds Pmax!, an overpressure condition occurs.

Q-RPT (Quartz Reference Pressure Transducer)	The transducer used by the RPM4-E-DWT for low uncertainty pressure measurement. May be designated as Hi or Lo depending on its position and role in the RPM4-E-DWT. Q-RPTs are designated by a leading A, G or BG (absolute, gauge or bi-directional gauge) followed by three numbers and a letter indicating the maximum range of the Q-RPT in kPa (nnnK) or MPa (nnnM).
Rate	A DISPLAY function in which the rate of change of pressure in pressure unit/second is displayed.
Ready/Not Ready	Front panel LED indication of when the pressure measured by RPM4-E-DWT's active Q-RPT is stable within the stability limit. Leading character of the second line when the inactive Q-RPT is displayed on the second line in Q-RPT DISPLAY mode.
RPT2x	Parallel measurement mode in which both Q-RPTs of an RPM4-E-DWT with two Q-RPTs are used together and the indicated pressure is the average of their measurements.
SDS (Self Defense System)	A system to protect Q-RPTs from overpressure made up of isolation and vent valves and internal operating logic. SDS is not used in RPM4-E-DWT A70M/A7M-AF.
Span	The difference between FS and the lowest point in a range. For example, the span of a 100 kPa FS range in negative gauge mode is nominally 200 kPa (from - 100 kPa to 100 kPa).
Stability Limit	A limit expressed in units of pressure per second (e.g., kPa/second). The stability limit is used as the <i>Ready/Not Ready</i> criterion. <i>Ready</i> if rate of change is less than stability limit. <i>Not Ready</i> if rate of change is greater than stability limit.
Target	The value from which deviations are measured in the Deviation DISPLAY function.
UL (Upper Limit)	A user settable maximum pressure limit. When pressure exceeds UL, RPM4-E-DWT beeps intermittently. In negative gauge measurement mode, there is also a user settable lower limit.
User Level	Levels of security that can be set to protect certain RPM4-E-DWT functions from being accessed.
QDUT	On-board automated test sequence that AutoRanges RPM4-E-DWT based on characteristics of the Device Under Test (DUT).